



# BEVERAGE-AIR®

YOUR COMPLETE REFRIGERATION SOURCE





# BEVERAGE-AIR®

## Your Complete Refrigeration Source

Beverage-Air is a leading domestic manufacturer of commercial refrigeration solutions, with a vast product offering including over 1,000 unique models across 31 product series and 11 product categories. Manufactured in Brookville, Pennsylvania and headquartered in Winston-Salem, North Carolina, Beverage-Air is committed to producing American made equipment for the foodservice market.

Founded in 1944, Beverage-Air was acquired by the Ali Group, one of the largest and most diversified global leaders in the foodservice and equipment industry, in 2008. Today, the Ali Group employs more than 14,000 people in 34 countries and operates 75 manufacturing facilities worldwide. Often times, second and third generation employees work side by side to drive innovative thinking and quality manufacturing.

Our expansive product offering allows us to meet any operator's refrigeration need whether it be front of the house, back of the house, food preparation or point of sale merchandising. With seemingly unlimited customizable options, award winning design innovation and unparalleled customer commitment, Beverage-Air continues to be a trusted partner in the food service industry. Whether it's national accounts, high-end restaurants or small operations, Beverage-Air has a solution for any food service application.







**Beverage-Air has a full range of premium refrigeration and food service equipment solutions to meet the diverse needs of restaurant, chain, retail, convenience store, educational, and healthcare settings.**





# BEVERAGE-AIR®

## AFTERMARKET SERVICES

As a Beverage-Air customer, our commitment to you continues with the ongoing support of our aftermarket services. This program provides you access to a full range of support tools.

### YOU HAVE ACCESS TO THE FOLLOWING:

- Ongoing technical support via telephone
- Product Customization
- Qualified parts distributor network
- Qualified network of reputable service technicians
- Service and maintenance dispatch
- Online manuals & parts breakdown
- Online warranty claims processing  
*(warranty at back of catalog)*

## CUSTOMER COMMITMENT

Committed to innovation, excellence, and customer satisfaction, Beverage-Air continually works to leverage efficiencies in manufacturing and distribution to benefit our customers.

### WE COMMIT ALL OF THE FOLLOWING TO YOU:

- Industry-leading quality and customer satisfaction
- Award-winning product innovation
- Competitive pricing
- Factory Inventory
- Energy efficient products
- Complete aftermarket services

### Factory Headquarters Sales Office

3779 Champion Blvd  
Winston-Salem, NC 27105  
Phone: (336) 245-6400  
Fax: (336) 245-6453  
Email: [sales@bevair.com](mailto:sales@bevair.com)  
Web: [www.beverage-air.com](http://www.beverage-air.com)

### Warranty Service Dispatch

(877) 866-1223

### Factory Technical Service

Phone: (800) 684-1199  
Fax: (800) 262-9381

### Factory Customer Service

Phone: (888) 845-9800  
Fax: (800) 253-5168





# TABLE OF CONTENTS

## Top Mount Reach-Ins 4

HR/HF	Horizon Series	6
TMR/TMF	TM Series	10
PR/PF	P Series	12
CT	Cross Temp Series	18

## Bottom Mount Reach-Ins 24

RB/FB	Vista Series	26
HBR/HBF	Horizon Series	30
SR/SF	Slate Series	36
RI	RI Series	38

## Warming Cabinets 42

HH	Horizon Series	44
PH	P Series	46

## Glass Door Merchandisers 52

MT	Marketeer Series	54
MM	MarketMax Series	56
CF/CT	Countertop Units	64
BDC/NC	Dipping Cabinets	66

## Open Air Merchandisers 72

BZ	Breeze Series	74
VM	VueMax	76

## Deli Cases 80

CDR	Deli Cases	82
-----	------------	----

## Food Prep Tables 84

SPE	Sandwich Prep Tables	86
DP	Pizza Prep Tables	98
SPE-S	Salad Bars	102

## Worktops & Undercounters 110

WTR/WTF	Worktops	112
UCR/UCF	Undercounters	124

## Chef Bases 134

WTRCS/WTFCS	Chef Bases	136
-------------	------------	-----

## Bar & Wine Equipment 140

DD/DZ/BM	Direct Draw	142
BM23/DZ24	Bar Mobile	146
BB/DZ	Back Bar	148
DW	Bottle Coolers	158
GF/FLG	Glass & Plate Chiller	160

## Milk Coolers 166

SM/SMF	Single Access	169
ST/STF	Dual Access	170

## Blast Chillers / Shock Freezers 172

CF/BF	Self Contained	174
BF	Remote	176
BF200	Blast Chiller/Freezer/Thawer	180

## Beverage-Air

Warranty	182
Contacts/Directory	184

©2023 Beverage-Air. All rights reserved. Beverage-Air, Horizon, Vista, Cross Temp, Marketeer, MarketMax, Breeze, and VueMax are trademarks of Beverage-Air. Beverage-Air cannot be held responsible for typographical or photographic errors. Photos of units in working environments may show custom or third-party modifications which may not be available from our factory. Beverage-Air, 3779 Champion Blvd, Winston-Salem, NC 27105





# TOP MOUNT REACH-INS

DESIGNED TO EXCEED EXPECTATIONS IN TOUGH KITCHEN ENVIRONMENTS



**Horizon Series**



**TM Series**



**P Series**



**Cross Temp®**

# HORIZON® SERIES

## Refrigerators & Freezers



**Designed to perform in  
high ambient conditions**

**3 year parts and labor warranty  
with an additional 4 year  
compressor part warranty**

**Made in USA**



### **Heavy Duty Construction**

2" CFC and HCFC-free foamed-in place polyurethane insulation

### **Full electronic Control**

with one-touch defrost

### **Multiple finish options**

### **Door locks standard**

Solid doors only (optional on glass door models)

### **Field-reversible doors**

Solid doors only

### **Cam-lift hinges**

with 120 degree stay open feature

**Sealed system makes service  
and maintenance quick and easy**

**LED lighting standard**

**Back rack airflow distribution system**

**Self-closing doors**

**6" heavy duty casters standard**

3" casters or 6" leg option available  
at no charge when specified on order

**Environmentally friendly,  
energy efficient R290 refrigerant**



**AVAILABLE DOORS**

- Solid (one full-door)
- Half Solid (two half-doors)
- Glass (one full-door)
- Half Glass (two half-doors)

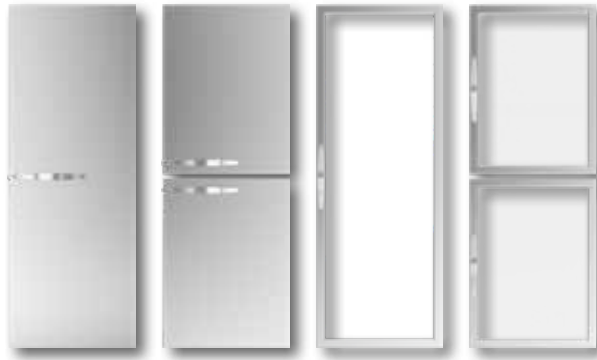

**EXTERIOR FINISHES**

- Stainless steel front with gray painted steel sides
- Stainless steel sides/front

**INTERIOR FINISHES**

- Corrosion resistant aluminum
- Stainless steel

**AVAILABLE OPTIONS**

- Left hinge doors
- Remote models available

**AVAILABLE ACCESSORIES**

- Tray Slides
- Additional shelves

**MOUNTING OPTIONS**

- 6" casters (standard)
- 6" legs
- 3" casters
- Flanged/seismic feet

**AGENCY CERTIFICATIONS**

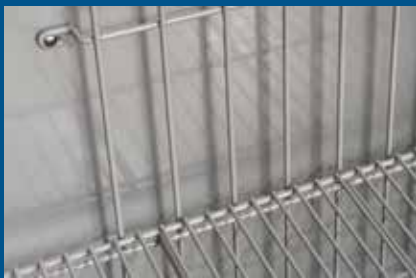

**BACK CHANNEL**  
to promote air flow



**FIELD-REVERSIBLE DOORS**  
for flexibility to get your kitchen set up exactly how you want it

**1, 2, AND 3 SECTION MODELS AVAILABLE**



# HORIZON® SERIES

## REFRIGERATORS

MAINTAINS PRODUCT TEMPERATURES OF 36-38°F.

SECTIONS	MODEL #	DOOR TYPE	DOORS/SHELVES	WIDTH	DEPTH	HEIGHT	VOLTS	HP	AMPS	CUBIC FEET
1 SECTION	HR1HC-1S	SOLID	1/3	26	33.63	78.5	115	1/4	2.7	21.17
	HR1HC-1HS	HALF SOLID	2/3							
	HR1HC-1G	GLASS	1/3				115	1/4	2.7	22.28
	HR1HC-1HG	HALF GLASS	2/3							
1 WIDE SECTION	HR1WHC-1S	SOLID	1/3	35	33.63	78.5	115	1/4	2.7	30.76
	HR1WHC-1G	GLASS								
2 SECTIONS	HR2HC-1S	SOLID	2/6	52	33.63	78.5	115	1/3	6	46.88
	HR2HC-1HS	HALF SOLID	4/6							
	HR2HC-1G	GLASS	2/6							
	HR2HC-1HG	HALF GLASS	4/6							
3 SECTIONS	HR3HC-1S	SOLID	3/9	78	33.63	78.5	115	1/3	6	71.52
	HR3HC-1HS	HALF SOLID	6/9							
	HR3HC-1G	GLASS	3/9							
	HR3HC-1HG	HALF GLASS	6/9							

Depth measurement includes handles. For total height, add 3 or 6 inches, based on your mounting choice.

### FINISH OPTIONS REFRIGERATOR & FREEZER

SUFFIX	EXAMPLE	EXTERIOR	INTERIOR
(standard)	HR1HC-1S	Stainless steel front with gray painted steel sides	Corrosion resistant aluminum
P	HRP1HC-1S	Stainless steel front with stainless steel sides	Corrosion resistant aluminum
S	HRS1HC-1S	Stainless steel front with gray painted steel sides	Stainless steel
PS	HRPS1HC-1S	Stainless steel front with stainless steel sides	Stainless steel

### AVAILABLE OPTIONS

SUFFIX	DESCRIPTION
18	Left hinge doors
R	Remote models available

Append suffix to model # when placing order. Ex: HR2-1S-18

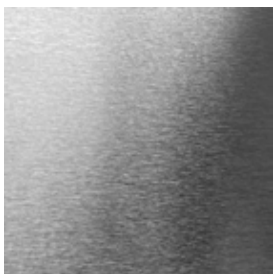

Stainless steel

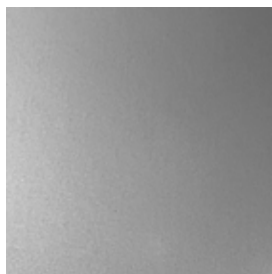

Gray painted steel



Left hinge door (-18)



**FREEZERS**

MAINTAINS PRODUCT TEMPERATURES OF -10°F.

SECTIONS	MODEL #	DOOR TYPE	DOORS/SHELVES	WIDTH	DEPTH	HEIGHT	VOLTS	HP	AMPS	CUBIC FEET
<b>1 SECTION</b>	<b>HF1HC-1S</b>	SOLID	1/3	<b>26</b>	<b>33.63</b>	<b>78.5</b>	115	3/4	11	21.06
	<b>HF1HC-1HS</b>	HALF SOLID	2/3							
	<b>HF1HC-1G</b>	GLASS	1/3							
	<b>HF1HC-1HG</b>	HALF GLASS	2/3							
<b>1 WIDE SECTION</b>	<b>HF1WHC-1S</b>	SOLID	1/3	<b>35</b>	<b>33.63</b>	<b>78.5</b>	115	3/4	11	30.76
<b>2 SECTIONS</b>	<b>HF2HC-1S</b>	SOLID	2/6	<b>52</b>	<b>33.63</b>	<b>78.5</b>	115	3/4+	10	45.2
	<b>HF2HC-1HS</b>	HALF SOLID	4/6							
	<b>HF2HC-1G</b>	GLASS	2/6				115	3/4 (X2)	13.2	
	<b>HF2HC-1HG</b>	HALF GLASS	4/6							
<b>3 SECTIONS</b>	<b>HF3HC-1S</b>	SOLID	3/9	<b>78</b>	<b>33.63</b>	<b>78.5</b>	115	3/4 (X2)	13.2	69
	<b>HF3HC-1HS</b>	HALF SOLID	6/9							
	<b>HF3HC-1G</b>	GLASS	3/9							
	<b>HF3HC-1HG</b>	HALF GLASS	6/9							

Depth measurement includes handles. For total height, add 3 or 6 inches, based on your mounting choice.

# ADAPTIVE DEFROST

- Reduces energy consumption up to 15%
- Units are able to provide a consistent product temperature throughout the cabinet even during defrost cycles
- Reduces the overall time defrosting versus traditional timed defrost
- Example: Adaptive Defrost: 48 min total in 4 cycles versus 60 min in 3 cycles (Traditional 8HR)
- High Ambient and Humidity testing shows the system's ability to perform better in high usage environments under unfavorable conditions

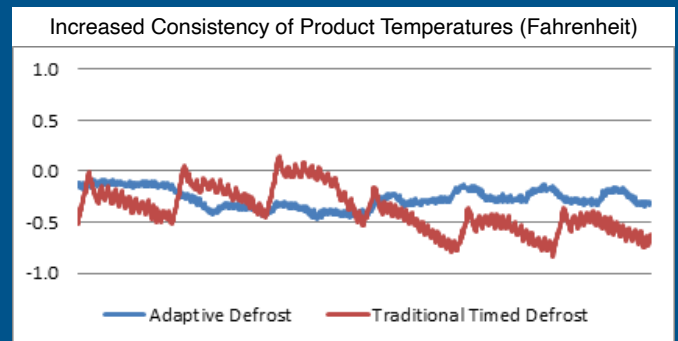

# TM SERIES

## Refrigerators & Freezers



**Stainless steel exterior and interior standard**

**Energy efficient R290 provides solution for all environmental concerns**

**2 year parts and labor warranty with an additional 5 year compressor part warranty**

**Full electronic control**

**Stainless steel exterior and interior**

**Easy access to the refrigeration**

**Uses environmentally friendly, energy efficient R290 refrigerant**

**Hot gas condensate evaporator**

**Hot gas face heater** (freezers only)

**Electric defrost heater**

**LED lighting standard**

**3 epoxy coated wire shelves**  
per section



### **FANS IN COOLER MODELS**

are set back and higher than the freezer fans, accommodating more product while holding its set temperature



### **FANS IN FREEZER MODELS**

increase the cold air flow to create consistent temperature throughout the unit



**REFRIGERATORS**

MAINTAINS PRODUCT TEMPERATURES OF 36-38°F.

SECTIONS	MODEL #	DOOR TYPE	DOORS/SHELVES	WIDTH	DEPTH	HEIGHT	VOLTS	HP	AMPS	CUBIC FEET
1 SECTION	TMR1HC-1S	SOLID	1/3	26.313	33.563	74.688	115	1/4	3	19
2 SECTIONS	TMR2HC-1S	SOLID	2/6	53.969	33.563	74.688	120	1/2	5.3	40

*Depth measurement includes handles. For total height, add 6 inches for casters.*

**FREEZERS**

MAINTAINS PRODUCT TEMPERATURES OF 0°F AND BELOW.

SECTIONS	MODEL #	DOOR TYPE	DOORS/SHELVES	WIDTH	DEPTH	HEIGHT	VOLTS	HP	AMPS	CUBIC FEET
1 SECTION	TMR1HC-1S	SOLID	1/3	26.313	33.563	74.688	120	1/2	4.73	19
2 SECTIONS	TMR2HC-1S	SOLID	2/6	53.969	33.563	74.688	120	1/2	8.3	40

*Depth measurement includes handles. For total height, add 6 inches for casters.*

**AVAILABLE DOORS**

- Solid (one full-door)

**EXTERIOR FINISHES**

- Stainless steel

**INTERIOR FINISHES**

- Stainless steel

**MOUNTING OPTIONS**

- 6" casters (standard)

**AGENCY CERTIFICATIONS**



# P SERIES

## Spec Line Refrigeration



**Maximum resistance to wear and tear with stainless steel breaker caps and door liners**

**Configurable interior gives ultimate flexibility for shelf and slide combinations**

**3 year parts and labor warranty with an additional 4 year compressor part warranty**

### **LED lighting**

### **Full electronic control**

### **Self-closing doors**

with 120° stay-open feature, on cam-lift hinges

### **Expansion valve technology**

Freezer only

### **Door locks standard**

Solid and Glass doors

### **Magnetic gasket attached to each door**

for positive seal

### **Sealed system makes service and maintenance quick and easy**

### **6" adjustable legs**

(3" casters or 6" caster option available at no charge when specified on order)

### **3 epoxy coated wire shelves**

per section

### **Removable access panel**

for ease of service and maintenance



**AVAILABLE DOORS**

- Solid (one full-door)
- Half Solid (two half-doors)
- Glass (one full-door)
- Half Glass (two half-doors)



**EXTERIOR FINISHES**

- Stainless steel

**INTERIOR FINISHES**

- Corrosion-resistant aluminum
- Stainless steel

**AVAILABLE OPTIONS**

- Left hinge doors
- Remote models available

**AVAILABLE ACCESSORIES**

- Additional shelves
- Tray slide kits (reach-in & pass-thru only)
- Stainless steel shelves
- Kick plate

**MOUNTING OPTIONS**

- 6" legs (standard)
- 6" casters
- 3" casters
- Flanged/seismic feet

**AGENCY CERTIFICATIONS**



**TRAY SLIDES A AVAILABLE**  
holds one 18x26" or two 14x18"



**TRAY SLIDES A/C AVAILABLE**  
hold one 18x26", or two 14x18", or two 12x20"

**1, 2, AND 3 SECTION MODELS AVAILABLE IN REACH-IN, PASS-THRU, ROLL-IN AND ROLL-THRU**





# P SERIES

## REFRIGERATORS - REACH IN

MAINTAINS PRODUCT TEMPERATURES OF 36-38°F.

SECTIONS	MODEL #	DOOR TYPE	DOORS/ SHELVES	WIDTH	DEPTH	HEIGHT	VOLTS	HP	AMPS	CUBIC FEET
1 SECTION	PR1HC-1AS	SOLID	1/3	26.50	34.63	77.75	115	1/3	6.5	21.01
	PR1HC-1AHS	HALF SOLID	2/3							
	PR1HC-1BG	GLASS	1/3	26.50	33.38	77.75		1/3	6.5	21.01
	PR1HC-1BHG	HALF GLASS	2/3							
2 SECTIONS	PR2HC-1AS	SOLID	2/6	52.13	34.63	77.75	115	1/3	6.5	44.57
	PR2HC-1AHS	HALF SOLID	4/6							
	PR2HC-1BG	GLASS	2/6	52.13	33.38	77.75		1/2	6.5	44.57
	PR2HC-1BHG	HALF GLASS	4/6							
3 SECTIONS	PR3HC-1AS	SOLID	3/9	77.75	34.63	77.75	115	3/4	8.5	68.34
	PR3HC-1AHS	HALF SOLID	6/9							
	PR3HC-1BG	GLASS	3/9	77.75	33.38	77.75		3/4	8.5	68.34
	PR3HC-1BHG	HALF GLASS	6/9							

Depth measurement includes handles. For total height, add 3 or 6 inches, based on your mounting choice.

## REFRIGERATORS - PASS-THRU

MAINTAINS PRODUCT TEMPERATURES OF 36-38°F.

SECTIONS	MODEL #	DOOR TYPE	DOORS/ SHELVES	WIDTH	DEPTH	HEIGHT	VOLTS	HP	AMPS	CUBIC FEET
1 SECTION	PRD1HC-1AS	SOLID	2/3	26.50	38.38	77.75	115	1/3	6.5	22.9
	PRD1HC-1AHS	HALF SOLID	4/3							
	PRD1HC-1BG	GLASS	2/3							
	PRD1HC-1BHG	HALF GLASS	4/3							
2 SECTIONS	PRD2HC-1AS	SOLID	4/6	52.13	38.38	77.75	115	1/3	6.5	48.33
	PRD2HC-1AHS	HALF SOLID	8/6							
	PRD2HC-1BG	GLASS	4/6				115	3/4	8.5	48.33
	PRD2HC-1BHG	HALF GLASS	8/6							
3 SECTIONS	PRD3HC-1AS	SOLID	6/9	77.75	38.38	77.75	115	3/4	8.5	74
	PRD3HC-1AHS	HALF SOLID	12/9							
	PRD3HC-1BG	GLASS	6/9				115	1/3 (X2)	10.8	75.1
	PRD3HC-1BHG	HALF GLASS	12/9							

Depth measurement includes handles. For total height, add 3 or 6 inches, based on your mounting choice.

**REFRIGERATORS - ROLL-IN**

MAINTAINS PRODUCT TEMPERATURES OF 36-38°F.

SECTIONS	MODEL #	DOOR TYPE	DOORS	WIDTH	DEPTH	HEIGHT	VOLTS	HP	AMPS	CUBIC FEET
1 SECTION	PRI1HC-1AS	SOLID	1	36.5	36.13	84	115	1/3	6.5	34.86
	PRI1XTHC-1AS					89.63				38.06
2 SECTIONS	PRI2HC-1AS	SOLID	2	68.88	36.13	84	115	3/4	8.5	70.84
	PRI2XTHC-1AS					89.63				77.35
3 SECTIONS	PRI3HC-1AS	SOLID	3	101.25	36.13	84	115	2x 1/3	10.8	106.81

*Depth measurement includes handles.*

**REFRIGERATORS - ROLL-THRU**

MAINTAINS PRODUCT TEMPERATURES OF 36-38°F.

SECTIONS	MODEL #	DOOR TYPE	DOORS	WIDTH	DEPTH	HEIGHT	VOLTS	HP	AMPS	CUBIC FEET
1 SECTION	PRT1HC-1AS	SOLID	2	36.5	39.88	84	115	3/4	8.5	38.69
	PRT1XTHC-1AS					89.63				42.27
2 SECTIONS	PRT2HC-1AS	SOLID	4	68.88	39.88	84	115	3/4	8.5	78.49
	PRT2XTHC-1AS					89.63				85.76
3 SECTIONS	PRT3HC-1AS	SOLID	6	101.25	39.88	84	115	2x 1/3	10.8	118.3

*Depth measurement includes handles.*

# P SERIES

## FREEZERS - REACH IN

MAINTAINS PRODUCT TEMPERATURES OF -10°F.

SECTIONS	MODEL #	DOOR TYPE	DOORS/ SHELVES	WIDTH	DEPTH	HEIGHT	VOLTS	HP	AMPS	CUBIC FEET
1 SECTION	PF1HC-1AS	SOLID	1/3	26.50	34.63	77.75	115	3/4	9.1	21.01
	PF1HC-1AHS	HALF SOLID	2/3							
	PF1HC-1BG	GLASS	1/3	26.50	33.38	77.75	115	3/4	9.1	21.01
	PF1HC-1BHG	HALF GLASS	2/3							
2 SECTIONS	PF2HC-1AS	SOLID	2/6	52.13	34.63	77.75	115	3/4+	10.5	44.57
	PF2HC-1AHS	HALF SOLID	4/6							
	PF2HC-1BG	GLASS	2/6	52.13	33.38	77.75	115	2 X 3/4	13.9	44.57
	PF2HC-1BHG	HALF GLASS	4/6							
3 SECTIONS	PF3HC-1AS	SOLID	3/9	77.75	34.63	77.75	115	2 X 3/4	13.9	68.34
	PF3HC-1AHS	HALF SOLID	6/9							
	PF3HC-1BG	GLASS	3/9	77.75	33.38	77.75	115	2 X 3/4	13.9	68.34
	PF3HC-1BHG	HALF GLASS	6/9							

Depth measurement includes handles. For total height, add 3 or 6 inches, based on your mounting choice.

## FREEZERS - PASS-THRU

MAINTAINS PRODUCT TEMPERATURES OF -10°F.

SECTIONS	MODEL #	DOOR TYPE	DOORS/ SHELVES	WIDTH	DEPTH	HEIGHT	VOLTS	HP	AMPS	CUBIC FEET
1 SECTION	PFD1HC-1AS	SOLID	2/3	26.50	38.38	77.75	115	3/4	9.1	22.9
	PFD1HC-1AHS	HALF SOLID	4/3							
	PFD1HC-1BG	GLASS	2/3	26.50	35.88	77.75	115	3/4	9.1	22.9
	PFD1HC-1BHG	HALF GLASS	4/3							
2 SECTIONS	PFD2HC-1AS	SOLID	4/6	52.13	38.38	77.75	115	3/4+	10.5	48.33
	PFD2HC-1AHS	HALF SOLID	8/6							
	PFD2HC-1BG	GLASS	4/6	52.13	35.88	77.75	115	2 X 3/4	13.9	48.33
	PFD2HC-1BHG	HALF GLASS	8/6							

Depth measurement includes handles. For total height, add 3 or 6 inches, based on your mounting choice.

**FREEZERS - ROLL-IN**

MAINTAINS PRODUCT TEMPERATURES OF -10°F.

SECTIONS	MODEL #	DOOR TYPE	DOORS	WIDTH	DEPTH	HEIGHT	VOLTS	HP	AMPS	CUBIC FEET
1 SECTION	PFI1HC-1AS	SOLID	1	36.5	36.13	84	115	3/4	9.1	34.86
	PFI1XTHC-1AS					89.63				38.06
2 SECTIONS	PFI2HC-1AS	SOLID	2	68.88	36.13	84	115	2 X 3/4	13.9	70.84
	PFI2XTHC-1AS					89.63				77.35
3 SECTIONS	PFI3HC-1AS	SOLID	3	101.25	36.13	84	115	2 X 3/4	13.9	106.81

Depth measurement includes handles.

**FREEZERS - ROLL-THRU**

MAINTAINS PRODUCT TEMPERATURES OF -10°F.

SECTIONS	MODEL #	DOOR TYPE	DOORS	WIDTH	DEPTH	HEIGHT	VOLTS	HP	AMPS	CUBIC FEET
1 SECTION	PFT1HC-1AS	SOLID	2	36.5	39.88	84	115	3/4+	10.5	38.69
	PFT1XTHC-1AS					89.63				42.27
2 SECTIONS	PFT2HC-1AS	SOLID	4	68.88	39.88	84	115	2 X 3/4	13.9	78.49
	PFT2XTHC-1AS					89.63				85.76

Depth measurement includes handles.

**DUAL-TEMPS - REACH-IN**

MAINTAINS PRODUCT TEMPERATURES OF 36-38°F (REFRIGERATOR), AND -10°F (FREEZER).

SECTIONS	MODEL #	DOOR TYPE	DOORS/SHELVES	WIDTH	DEPTH	HEIGHT	VOLTS	HP	AMPS	CUBIC FEET
2 HALF SECTIONS (1 REFRIGERATOR 1 FREEZER)	PRF12-12HC-1HS	HALF SOLID	2/4	26.63	34.63	77.75	115 (X2)	R: 1/3 F: 1/3	R: 7.5 F: 7.5	R: 9 F: 9
	PRF12-12HC-1HG	HALF GLASS								R: 9 F: 9
2 SECTIONS (1 REFRIGERATOR 1 FREEZER)	PRF24-24HC-1AS	SOLID	2/6	52	33	77.75	115 (X2)	R: 1/3 F: 3/4	R: 6.5 F: 9.1	R: 21 F: 21
	PRF24-24HC-1AHS	HALF SOLID								R: 21 F: 21

Depth measurement includes handles. For total height, add 3 or 6 inches, based on your mounting choice.



# CROSS TEMP<sup>®</sup> SERIES

## Convertible Refrigeration



**NEW 2-SECTION SIZE!**

**Variable speed compressor technology achieves up to 30% more energy efficiency compared to a single-speed**

**3 year parts and labor warranty with an additional 4 year compressor part warranty**

### **Temperature range of -15 to 40° F**

**Modulates coil temp to achieve desired set point**  
while achieving maximum energy efficiency

### **Single cabinet configurable to all menu initiatives**

**Intuitive compressor**  
adjusts for optimal effectiveness in high-use situations

**Quicker pull-down**  
for both air and product temperatures

### **Improved product stability**

### **Smart-defrost**

### **Expansion valve**

### **Rapid-recovery after defrost**

consistent product temperature and ensures food quality

### **Door locks standard**

Solid doors only (optional on glass door models)

### **Field-reversible doors**

(except for CT12-12HC models)

**Featuring environmentally friendly energy efficient R290 refrigerant**



**AVAILABLE DOORS**

- Solid (one full-door)
- Half Solid (two half-doors)
- Glass (one full-door)
- Half Glass (two half-doors)

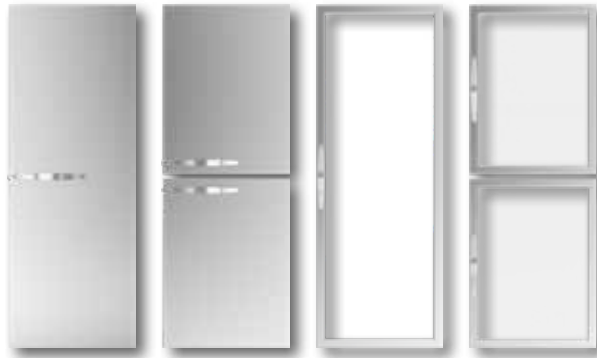

**EXTERIOR FINISHES**

- Stainless steel front with gray painted steel sides
- Stainless steel sides/front

**INTERIOR FINISHES**

- Corrosion resistant aluminum
- Stainless steel

**AVAILABLE OPTIONS**

- Left hinge doors

**AVAILABLE ACCESSORIES**

- Tray Slides
- Additional shelves

**MOUNTING OPTIONS**

- 6" casters (standard)
- 6" legs
- 3" casters (single section only)
- Flanged/seismic feet

**AGENCY CERTIFICATIONS**



**EASY-TO-USE CONTROLLER**  
to quickly adjust set points



**VARIABLE SPEED SYSTEM**  
modulates coil temp

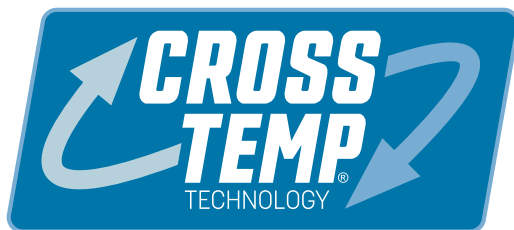

**Easily converts from refrigerator to freezer**  
with Beverage-Air's exclusive Cross Temp® technology

**WHAT IS CROSS TEMP® TECHNOLOGY?**

New from Beverage-Air, Cross Temp™ technology allows the user to easily switch the unit back and forth from refrigerator to freezer as needed, with a range of -15° to 40°F.

**THE PURPOSE OF CROSS TEMP®**

Simply put, Cross Temp technology lets the user get the most flexibility from the unit, by letting them switch from fridge to freezer as their menus change with the seasons and initiatives, including ice-cream storage.

**IS CROSS TEMP ENERGY EFFICIENT?**

The Cross Temp® units are intuitive and self-adjust for optimal effectiveness based on usage. Even in high-usage situations, Cross Temp units adjust to maintain maximum energy efficiency.

**HOW LONG DOES THE CONVERSION TAKE?**

On average, a Cross Temp unit can convert from refrigerator to freezer or vice versa, in under an hour. (Conditions and results will vary)

# CROSS TEMP<sup>®</sup> SERIES

## 1 & 2 SECTIONS

CAN CONVERT BETWEEN FREEZER AND REFRIGERATOR  
TEMPERATURES FROM -15° TO 40°F

SECTIONS	MODEL #	DOOR TYPE	DOORS/ SHELVES	WIDTH	DEPTH	HEIGHT	VOLTS	HP	AMPS	CUBIC FEET
1 SECTION	CT1HC-1S	SOLID	1/3	26	33.63	78.5	115	4/5	8	23.1
	CT1HC-1HS	HALF SOLID	2/3							
	CT1HC-1G	GLASS	1/3				115	4/5	8	23.1
	CT1HC-1HG	HALF GLASS	2/3							
2 SECTIONS	CT2HC-1S	SOLID	2/6	52	33.63	79	115	4/5 (X2)	13.2	45.2
	CT2HC-1G	GLASS								

Depth measurement includes handles. For total height, add 3 or 6 inches, based on your mounting choice.

## DUAL TEMP - 2 HALF SECTIONS

CAN CONVERT BETWEEN FREEZER AND REFRIGERATOR  
TEMPERATURES FROM -15° TO 40°F

SECTIONS	MODEL #	DOOR TYPE	DOORS/ SHELVES	WIDTH	DEPTH	HEIGHT	VOLTS	HP	AMPS	CUBIC FEET
2 HALF SECTIONS (STACKED)	CT12-12HC-1HS	HALF SOLID	2/4	26.5	34.88	78.13	115 (X2)	1: 1/3 2: 1/3	1: 7.5 2: 7.5	1: 9 2: 9
	CT12-12HC-1HG	HALF GLASS								

Depth measurement includes handles. For total height, add 3 or 6 inches, based on your mounting choice.







# Top Mount Reach-In Accessories

DESCRIPTION	UNIT(S)	PART NUMBER
<b>SHELVING / ORGANIZERS</b>		
Epoxy Coated Wire Shelf	H Series Flat Shelving 1 Door Unit	412-020D-01
Epoxy Coated Wire Shelf	H Series Flat Shelving HR1W Units	412-023D-01
Epoxy Coated Wire Shelf	H Series Flat Shelving 2 Door Unit	412-021D-01
Epoxy Coated Center Shelf	H Series Flat Shelving 3 Door Unit	412-022D-01
Epoxy Coated Wire Shelf	H Series Flat Shelving 3 Door Unit	412-021D-01
Epoxy Coated Wire Shelf	TM Series Flat Shelving	3062152
Epoxy Coated Wire Shelf	P Series, 1 section	50597706
Epoxy Coated Wire Shelf	P Series, 2 section or 3 section (left or right)	50597806
Epoxy Coated Wire Shelf	P Series, 3 section (center)	50597906
Epoxy Coated Wire Shelf	Cross Temp Flat Shelving 1 Door Unit (CT1)	403-889D-01
Epoxy Coated Wire Shelf	Cross Temp Flat Shelving (CT12)	50597706
S/S Shelves	H Series Flat Shelving 1 Door Unit	412-020D-04
S/S Shelves	H Series Flat Shelving 1 Door Wide Unit	412-023D-04
S/S Shelves	H Series Flat Shelving 2 & 3 Door Unit	412-021D-04
S/S Shelves	H Series Flat Shelving 3 Door Unit-Center	412-022D-04
S/S Shelves	Cross Temp Flat Shelving 1 Door Unit (CT1)	403-889D-04
Shelf Clip	Any H Series Unit / Cross Temp 1 Door Unit (CT1)	403-169A
Shelf Clips (bag of 12)	Any TM Series Unit	2079798
Shelf Clip	P Series / Cross Temp (CT12)	50022601
<b>MOUNTING</b>		
6" Caster (set of four)	Any H Series Unit / Cross Temp 1 Door Unit (CT1)	61C01-001A
3" Caster (set of four)	Any H Series Unit / Cross Temp 1 Door Unit (CT1)	61C01-013A
6" Black Leg (set of four)	Any H Series Unit / Cross Temp 1 Door Unit (CT1)	58B02-001A
6" Seismic/Flanged Legs (set of four)	Any H Series Unit / Cross Temp 1 Door Unit (CT1)	00C31-055A
6" Caster (no brake) (single caster)	Any TM Series Unit	3071428
6" Caster (with brake) (single caster)	Any TM Series Unit	3071429
6" Casters (set of four)	P Series	0-0140-105S
3" Casters (set of four)	P Series	0-0140-103S
6" Seismic/Flanged Legs (set of four)	P Series	00C26-028A
<b>ADDITIONAL ACCESSORIES</b>		
Door Lock	Glass Door H Series / Glass Door Cross Temp (CT1) (per door)	61C11S032A
Door lock	P Series	50597111
S/S Breakers Half Door	Any H Series Unit	61C08-019A
S/S Breakers Full Door	Any H Series Unit (except extra-wide units)	61C08-020A

# Tray Slides

DESCRIPTION	UNIT(S)	PART NUMBER
-------------	---------	-------------

## INDIVIDUAL TRAY SLIDES

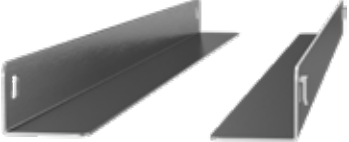
<b>1 pair of type "A" tray slides</b>	H-Series / P-Series / Cross Temp Series	<b>10601211S</b>											
 <p><b>Pilaster and mounting hardware not included. Contact us for hardware selection.</b></p>	<b>Bottom support for (1) 18x26" pan, or (2) 14x18" pans</b>												
	<table border="1"> <thead> <tr> <th>SPACING</th> <th>2"</th> <th>3"</th> <th>4"</th> </tr> </thead> <tbody> <tr> <td>Full Door</td> <td>26</td> <td>18</td> <td>13</td> </tr> <tr> <td>Half Door</td> <td>12</td> <td>8</td> <td>6</td> </tr> </tbody> </table>	SPACING	2"	3"	4"	Full Door	26	18	13	Half Door	12	8	6
SPACING	2"	3"	4"										
Full Door	26	18	13										
Half Door	12	8	6										

<b>1 pair of type "A/C" tray slides</b>	H-Series / Cross Temp Series (except CT12)	<b>10601201S</b>											
 <p><b>Pilaster and mounting hardware not included. Contact us for hardware selection.</b></p>	<b>Bottom support for (1) 18x26" pan, or (2) 14x18" pans, or (2) 12x20" pans</b>												
	<table border="1"> <thead> <tr> <th>SPACING</th> <th>2"</th> <th>3"</th> <th>4"</th> </tr> </thead> <tbody> <tr> <td>Full Door</td> <td>26</td> <td>18</td> <td>13</td> </tr> <tr> <td>Half Door</td> <td>12</td> <td>8</td> <td>6</td> </tr> </tbody> </table>	SPACING	2"	3"	4"	Full Door	26	18	13	Half Door	12	8	6
SPACING	2"	3"	4"										
Full Door	26	18	13										
Half Door	12	8	6										

## TRAY SLIDE KITS

### EPOXY COATED WIRE ROD TRAY SLIDE KIT #4 - 1/2 SECTION

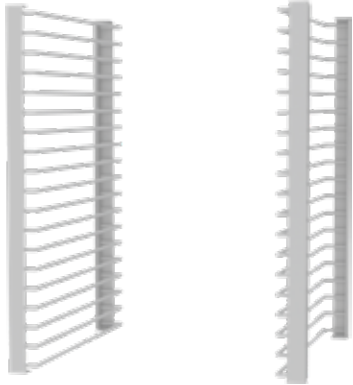
<p style="text-align: center;"><b>1/2 SECTION 19 SLOTS</b></p> 	H Series - 1 Section Unit	<b>61C31-251A-01</b> (order 2)
	H Series - 2 Section Unit	<b>61C31-251A-02</b> (order 4)
	H Series - 3 Section Unit	<b>61C31-251A-03</b> (order 6)



# BOTTOM MOUNT REACH-INS

MULTIPLE OPTIONS TO MEET ANY COOLING CHALLENGE OR ENVIRONMENT



**Vista Series**



**Horizon Series**



**Slate Series**



**RI Series**



# VISTA® SERIES

## Refrigerators & Freezers



**Designed to perform in  
high ambient conditions**

**3 year parts and labor warranty  
with an additional 4 year  
compressor part warranty**

**Made in USA**

### **Full electronic control**

#### **Door locks standard**

(solid doors only, optional on glass door models)

#### **One piece grille**

#### **Cartridge style door hinges**

with 120 degree stay-open feature

#### **LED lighting standard**

#### **Self-closing doors**

### **Right and Left hinged models available**

(specify at time of order)

### **6" heavy duty casters standard**

(3" casters or 6" leg option available  
at no charge when specified on order)

### **Environmentally friendly, energy efficient R290 refrigerant**



**AVAILABLE DOORS**

- Solid (one full-door)
- Glass (one full-door)



**EXTERIOR FINISHES**

- Stainless steel front with gray painted steel sides

**INTERIOR FINISHES**

- Corrosion resistant aluminum

**AVAILABLE OPTIONS**

- Left hinge doors
- Remote models available

**AVAILABLE ACCESSORIES**

- Additional shelves
- Tray slide kits

**MOUNTING OPTIONS**

- 6" casters (standard)
- 6" legs
- 3" casters
- Flanged/seismic feet

**AGENCY CERTIFICATIONS**



**DOOR LOCKS STANDARD**

on solid door units for loss prevention (available as an option for glass doors)



**FULL ELECTRONIC CONTROL**

with easy to read digital display

**1, 2, AND 3 SECTION MODELS AVAILABLE**



# VISTA<sup>®</sup> SERIES

## REFRIGERATORS

MAINTAINS PRODUCT TEMPERATURES OF 36-38°F.

SECTIONS	MODEL #	DOOR TYPE	DOORS/ SHELVES	WIDTH	DEPTH	HEIGHT	VOLTS	HP	AMPS	CUBIC FEET
1 SECTION	RB12HC-1S	SOLID	1/4	24	26	62	115	1/6	2	12.06
1 SHALLOW SECTION	RB19HC-1S	SOLID	1/3	27.25	27.56	78	115	1/4	3	17.87
	RB19HC-1G	GLASS								
1 SECTION	RB23HC-1S	SOLID	1/3	27.25	33.75	78	115	1/4	3	23.1
	RB23HC-1G	GLASS								
1 SECTION	RB27HC-1S	SOLID	1/3	30	33.75	78	115	1/4	3	25.88
	RB27HC-1G	GLASS								
2 SECTIONS	RB35HC-1S	SOLID	2/6	39.5	33.75	78	115	1/4	2.4	36.87
	RB35HC-1G									
2 SECTIONS	RB44HC-1S	SOLID	2/6	47	33.75	78	115	1/3	5.4	44
	RB44HC-1G	GLASS								
2 SECTIONS	RB49HC-1S	SOLID	2/6	52	33.75	78	115	1/3	5.4	46.15
	RB49HC-1G	GLASS								
3 SECTIONS	RB72HC-1S	SOLID	3/9	75	33.75	78	115	1/2	6.2	68.93
	RB72HC-1G	GLASS								

*Depth measurement includes handles. For total height, add 3 or 6 inches, based on your mounting choice.*

**FREEZERS**

MAINTAINS PRODUCT TEMPERATURES OF -10°F.

SECTIONS	MODEL #	DOOR TYPE	DOORS/ SHELVES	WIDTH	DEPTH	HEIGHT	VOLTS	HP	AMPS	CUBIC FEET
<b>1 SECTION</b>	<b>FB12HC-1S</b>	SOLID	1/3	<b>24</b>	<b>26</b>	<b>62</b>	115	1/2	5	11.9
<b>1 SHALLOW SECTION</b>	<b>FB19HC-1S</b>	SOLID	1/3	<b>27.25</b>	<b>27.56</b>	<b>78</b>	115	3/4	7.5	17.87
	<b>FB19HC-1G</b>	GLASS								
<b>1 SECTION</b>	<b>FB23HC-1S</b>	SOLID	1/3	<b>27.25</b>	<b>33.75</b>	<b>78</b>	115	3/4	7.5	22.5
	<b>FB23HC-1G</b>	GLASS								
<b>1 SECTION</b>	<b>FB27HC-1S</b>	SOLID	1/3	<b>30</b>	<b>33.75</b>	<b>78</b>	115	3/4	7.5	26.57
	<b>FB27HC-1G</b>	GLASS								
<b>2 SECTIONS</b>	<b>FB35HC-1S</b>	SOLID	2/6	<b>39.5</b>	<b>33.75</b>	<b>78</b>	115	3/4	11	36.87
	<b>FB35HC-1G</b>									
<b>2 SECTIONS</b>	<b>FB44HC-1S</b>	SOLID	2/6	<b>47</b>	<b>33.75</b>	<b>78</b>	115	3/4	11	44
	<b>FB44HC-1G</b>	GLASS								
<b>2 SECTIONS</b>	<b>FB49HC-1S</b>	SOLID	2/6	<b>52</b>	<b>33.75</b>	<b>78</b>	115	3/4	11	46.2
	<b>FB49HC-1G</b>	GLASS								
<b>3 SECTIONS</b>	<b>FB72HC-5S</b>	SOLID	3/9	<b>75</b>	<b>33.75</b>	<b>78</b>	230	3/4 (X2)	14	68.5
	<b>FB72HC-5G</b>	GLASS								

*Depth measurement includes handles. For total height, add 3 or 6 inches, based on your mounting choice.*

# HORIZON<sup>®</sup> SERIES

## Refrigerators & Freezers



**Designed to perform in  
high ambient conditions**

**3 year parts and labor warranty  
with an additional 4 year  
compressor part warranty**

**Made in USA**

### **Heavy Duty Construction**

(2" CFC and HCFC-free foamed-in place polyurethane insulation)

### **Full electronic Control**

with one-touch defrost

### **Door locks standard**

(solid doors only, optional on glass door models)

### **Cartridge-style hinges**

with 120 degree stay open feature

### **LED lighting standard**

### **Self-closing doors**

### **6" heavy duty casters standard**

(3" casters or 6" leg option available at no charge when specified on order)

**Environmentally friendly,  
energy efficient R290 refrigerant**





**AVAILABLE DOORS**

- Solid (one full-door)
- Half Solid (two half-doors)
- Glass (one full-door)
- Half Glass (two half-doors)



**EXTERIOR FINISHES**

- Stainless steel

**INTERIOR FINISHES**

- Stainless steel

**AVAILABLE OPTIONS**

- Left hinge doors
- Remote models available

**AVAILABLE ACCESSORIES**

- Additional shelves
- Tray slide kits
- Wine models
- Dual-temp

**MOUNTING OPTIONS**

- 6" casters (standard)
- 6" legs
- 3" casters
- Flanged/seismic feet

**AGENCY CERTIFICATIONS**



**DOOR LOCKS STANDARD**

on solid door units for loss prevention (available as an option for glass doors)



**FULL ELECTRONIC CONTROL**

with easy to read digital display

**1, 2, AND 3 SECTION MODELS AVAILABLE**



# HORIZON® SERIES

## REFRIGERATORS

MAINTAINS PRODUCT TEMPERATURES OF 36-38°F.

SECTIONS	MODEL #	DOOR TYPE	DOORS/ SHELVES	WIDTH	DEPTH	HEIGHT	VOLTS	HP	AMPS	CUBIC FEET
1 SECTION	HBR12HC-1	SOLID	1/4	24	26	62	115	1/6	2	12.06
1 SHALLOW SECTION	HBR19HC-1	SOLID	1/3	27.25	27.75	78	115	1/4	3	17.87
	HBR19HC-1-G	GLASS								
1 SECTION	HBR23HC-1	SOLID	1/3	27.25	33.75	78	115	1/4	3	23.1
	HBR23HC-1-HS	HALF SOLID	2/3							
	HBR23HC-1-G	GLASS	1/3							
	HBR23HC-1-HG	HALF GLASS	2/3							
1 SECTION	HBR27HC-1	SOLID	1/3	30	33.75	78	115	1/4	3	25.88
	HBR27HC-1-HS	HALF SOLID	2/3							
	HBR27HC-1-G	GLASS	1/3							
	HBR27HC-1-HG	HALF GLASS	2/3							
2 SECTIONS	HBR35HC-1	SOLID	2/6	39.5	33.75	78	115	1/4	2.4	36.87
	HBR35HC-1-G	GLASS								
2 SECTIONS	HBR44HC-1	SOLID	2/6	47	33.75	78	115	1/3	5.4	40.2
	HBR44HC-1-HS	HALF SOLID	4/6							
	HBR44HC-1-G	GLASS	2/6							
	HBR44HC-1-HG	HALF GLASS	4/6							
2 SECTIONS	HBR49HC-1	SOLID	2/6	52	33.75	78	115	1/3	5.4	46.15
	HBR49HC-1-HS	HALF SOLID	4/6							
	HBR49HC-1-G	GLASS	2/6							
	HBR49HC-1-HG	HALF GLASS	4/6							
3 SECTIONS	HBR72HC-1	SOLID	3/9	75	33.75	78	115	1/2	6.2	68.93
	HBR72HC-1-HS	HALF SOLID	6/9							
	HBR72HC-1-G	GLASS	3/9							
	HBR72HC-1-HG	HALF GLASS	6/9							

Depth measurement includes handles. For total height, add 3 or 6 inches, based on your mounting choice.

**FREEZERS**

MAINTAINS PRODUCT TEMPERATURES OF -10°F.

SECTIONS	MODEL #	DOOR TYPE	DOORS/ SHELVES	WIDTH	DEPTH	HEIGHT	VOLTS	HP	AMPS	CUBIC FEET
<b>1 SECTION</b>	<b>HBF12HC-1</b>	SOLID	1/3	<b>24</b>	<b>26</b>	<b>62</b>	115	1/2	5	11.9
	<b>HBF12HC-1-G</b>	GLASS								
<b>1 SHALLOW SECTION</b>	<b>HBF19HC-1</b>	SOLID	1/3	<b>27.25</b>	<b>27.75</b>	<b>78</b>	115	3/4	7.5	17.87
	<b>HBF19HC-1-G</b>	GLASS								
<b>1 SECTION</b>	<b>HBF23HC-1</b>	SOLID	1/2	<b>27.25</b>	<b>33.75</b>	<b>78</b>	115	3/4	7.5	22.5
	<b>HBF23HC-1-HS</b>	HALF SOLID	2/2							
	<b>HBF23HC-1-G</b>	GLASS	1/2							
	<b>HBF23HC-1-HG</b>	HALF GLASS								
<b>1 SECTION</b>	<b>HBF27HC-1</b>	SOLID	1/2	<b>30</b>	<b>33.75</b>	<b>78</b>	115	3/4	7.5	26.57
	<b>HBF27HC-1-HS</b>	HALF SOLID	2/2							
	<b>HBF27HC-1-G</b>	GLASS	1/2							
<b>2 SECTIONS</b>	<b>HBF35HC-1</b>	SOLID	2/6	<b>39.5</b>	<b>33.75</b>	<b>78</b>	115	3/4	11	36.87
	<b>HBF35HC-1-G</b>	GLASS								
<b>2 SECTIONS</b>	<b>HBF44HC-1</b>	SOLID	2/6	<b>47</b>	<b>33.75</b>	<b>78</b>	115	3/4	11	44
	<b>HBF44HC-1-HS</b>	HALF SOLID	4/6							
	<b>HBF44HC-1-G</b>	GLASS	2/6							
<b>2 SECTIONS</b>	<b>HBF49HC-1</b>	SOLID	2/6	<b>52</b>	<b>33.75</b>	<b>78</b>	115	3/4	11	46.2
	<b>HBF49HC-1-HS</b>	HALF SOLID	4/6							
	<b>HBF49HC-1-G</b>	GLASS	2/6							
<b>3 SECTIONS</b>	<b>HBF72HC-5</b>	SOLID	3/9	<b>75</b>	<b>33.75</b>	<b>78</b>	230	3/4 (X2)	14	68.5
	<b>HBF72HC-5-HS</b>	HALF SOLID	6/9							
	<b>HBF72HC-5-G</b>	GLASS	3/9							

# HORIZON® SERIES

## DUAL-TEMPS

MAINTAINS PRODUCT TEMPERATURES OF 36-38°F (REFRIGERATOR), AND -10°F (FREEZER).

SECTIONS	MODEL #	DOOR TYPE	DOORS/ SHELVES	WIDTH	DEPTH	HEIGHT	VOLTS	HP	AMPS	CUBIC FEET
2 HALF SECTIONS (1 REFRIGERATOR 1 FREEZER)	HBRF23HC-1-A	HALF SOLID	2/4	27.25	33.75	78	115 (X2)	R: 1/10 F: 1/2	R: 2 F: 4	R: 11.5 F: 8.65
2 SECTIONS (1 REFRIGERATOR 1 FREEZER)	HBRF49HC-1-A	SOLID	2/6	52	33.75	78	115 (X2)	R: 1/4 F: 3/4	R: 2.4 F: 7.5	R: 21.01 F: 21.01
	HBRF49HC-1-A-G	GLASS								
3 SECTIONS (1 REFRIGERATOR 2 FREEZER)	HBRF72HC-1-B	SOLID	3/9	75	33.75	78	115 (X2)	R: 1/4 F: 1	R: 2.4 F: 11	R: 19.62 F: 44.85
	HBRF72HC-1-B-G	GLASS								

\*Freezers powered by 115/208-230 volts are designed for field wiring (requires 4-wire electrical circuit, hard-wired).

Depth measurement includes handles.



HBRF72HC-1-B

**All options for Horizon Bottom Mount Dual Temps are specified within the model number using the designated codes described below.**

**HBRF23HC EXAMPLE**

Customer orders a HBRF23HC-1-A

- The refrigerator will be on the TOP with Right hinged door. The freezer will be on the BOTTOM with Right hinged door. (RF)

HB (RF, FR) 23 - COOLER CONFIGURATIONS	
HALF DOOR ON TOP - HALF DOOR ON BOTTOM	
<b>FR</b>	Freezer on the Top with Right Hinged Door, Refrigerator on the Bottom with Right Hinged Door
<b>RF</b>	Refrigerator on the Top with Right Hinged Door, Freezer on the Bottom with Right Hinged Door
<b>RR</b>	One Refrigerator on Top, second Refrigerator on the Bottom, Right Hinged Doors
SPECIAL DOOR OPENINGS - ADD NUMBER TO END OF MODEL NUMBER	
<b>-18</b>	All Left Hinged Doors

**HBRF49HC EXAMPLE**

Customer orders a HBRF49HC-1-A

- The refrigerator will be on the LEFT with Left hinged door. The freezer will be on the RIGHT with Right hinged door. (RF)

HB (RF, FR) 49 - COOLER CONFIGURATIONS	
SINGLE DOOR ON LEFT - SINGLE DOOR ON RIGHT	
<b>FR</b>	Freezer on the Left with Left Hinged Door, Refrigerator on the Right with Right Hinged Door
<b>RF</b>	Refrigerator on the Left with Left Hinged Door, Freezer on the Right with Right Hinged Door
<b>RR</b>	One Refrigerator on the Left, second Refrigerator on Right
SPECIAL DOOR OPENINGS - ADD NUMBER TO END OF MODEL NUMBER	
<b>-18</b>	All Left Hinged Doors
<b>-015</b>	All Right Hinged Doors

**HBRF72 EXAMPLE**

Customer orders a HBRF72HC-1-B

- The refrigerator will be on the left and freezer will be on the right (RF)
- Single section on the left, and double section on the right (B)

HB (RF, FR) 72 - COOLER CONFIGURATIONS	
Refrigerator/Freezer Location	
<b>FR</b>	Freezer on the Left, Refrigerator on the right
<b>RF</b>	Refrigerator on the Left, Freezer on the right
<b>RR</b>	One Refrigerator on the Left, second Refrigerator on Right
Door Configuration	
<b>B</b>	Single section on left, Double section on right
<b>C</b>	Double section on left, Single section on right

B DOOR OPENINGS - ADD NUMBER TO END OF MODEL NUMBER	
	Standard - Single section on the Left with Left Hinged Door, 2 Door Section on the Right with Left/Right Hinged Doors
<b>-282</b>	Single section on the Left with Left Hinged Door, 2 Door Section on the Right with 2 Right Hinged Doors
<b>-18</b>	Single section on the Left with Left Hinged Door, 2 Door Section on the Right with 2 Left Hinged Doors
<b>-015</b>	Single section on the Left with Right Hinged Door, 2 Door Section on the Right with 2 Right Hinged Doors

C DOOR OPENINGS - ADD NUMBER TO END OF MODEL NUMBER	
	Standard - 2 Door Section on the Left with Left/Right Hinged Doors, Single Door Section on the Right with Right Hinged Door
<b>-18</b>	2 Door Section on the Left with 2 Left Hinged Doors, Single Door Section on the Right with Left Hinged Door
<b>-015</b>	2 Door Section on the Left with 2 Right Hinged Doors, Single Door Section on the Right with Right Hinged Door
<b>-103</b>	2 Door Section on the Left with 2 Left Hinged Doors, Single Door Section on the Right with Right Hinged Door



# SLATE SERIES

## Refrigerators & Freezers



**Features and style not found in other entry level bottom mount units**

**2 year parts and labor warranty with an additional 5 year compressor part warranty**

**Modern slate exterior finish looks great and is easy to clean**

**Uses environmentally friendly, energy efficient R290 refrigerant**

**15-25% cost reduction versus other Beverage-Air entry level bottom mount models**

**Refrigerator has mechanical control**

**Freezer has electronic control**

**LED lighting standard**

**Door locks standard**

**3 epoxy coated wire shelves per section**



### **MODERN SLATE FINISH**

contrasts beautifully with the stainless steel doors and grille.



### **LED LIGHTING**

for dynamic product presentation

**REFRIGERATORS**

MAINTAINS PRODUCT TEMPERATURES OF 36-38°F.

SECTIONS	MODEL #	DOOR TYPE	DOORS/SHELVES	WIDTH	DEPTH	HEIGHT	VOLTS	HP	AMPS	CUBIC FEET
<b>1 SECTION</b>	<b>SR1HC-1S</b>	SOLID	1/3	<b>30.1</b>	<b>33.5</b>	<b>77.8</b>	120	1/5	5	23
<b>2 SECTIONS</b>	<b>SR2HC-1S</b>	SOLID	2/6	<b>52</b>	<b>34.9</b>	<b>77.8</b>	120	1/4	6	43

*Depth measurement includes handles. For total height, add 6 inches for casters.*

**FREEZERS**

MAINTAINS PRODUCT TEMPERATURES OF 0°F.

SECTIONS	MODEL #	DOOR TYPE	DOORS/SHELVES	WIDTH	DEPTH	HEIGHT	VOLTS	HP	AMPS	CUBIC FEET
<b>1 SECTION</b>	<b>SF1HC-1S</b>	SOLID	1/3	<b>30.1</b>	<b>33.5</b>	<b>77.8</b>	120	1/3	5	23
<b>2 SECTIONS</b>	<b>SF2HC-1S</b>	SOLID	2/6	<b>52</b>	<b>34.9</b>	<b>77.8</b>	120	1/2	6	43

*Depth measurement includes handles. For total height, add 6 inches for casters.*

**AVAILABLE DOORS**

- Solid (one full-door)

**EXTERIOR FINISHES**

- Stainless steel doors and grille, with modern slate finish sides

**INTERIOR FINISHES**

- White coated steel walls with slate finish interior door

**MOUNTING OPTIONS**

- 6" casters (standard)

**AGENCY CERTIFICATIONS**



**Intertek**



**Intertek**

# RI SERIES

## Refrigerators



**Designed to perform in high ambient conditions**

**3 year parts and labor warranty with an additional 4 year compressor part warranty**

**Made in USA**

### **Compact design**

to fit challenging kitchen layouts

### **Heavy Duty Construction**

(2" CFC and HCFC-free foamed-in place polyurethane insulation)

### **Cartridge-style hinges**

with 120 degree stay open feature

### **LED lighting standard**

### **Self-closing doors**

### **6" heavy duty casters standard**

(3" casters or 6" leg option available at no charge when specified on order)

**Uses environmentally friendly, energy efficient R290 refrigerant**



### **FULL ELECTRONIC CONTROL**

with easy to read digital display



### **BUILT-IN LED LIGHTS**

Improved LED lighting for better product display

**REFRIGERATORS (REACH-IN)**

MAINTAINS PRODUCT TEMPERATURES OF 36-38°F.

SECTIONS	MODEL #	DOOR TYPE	DOORS/SHELVES	WIDTH	DEPTH	HEIGHT	VOLTS	HP	AMPS	CUBIC FEET
1 SECTION	RI18HC	SOLID	1/4	27.25	29.25	69	115	1/4	5.5	16.85
	RI18HC-HS	HALF SOLID	2/5							
	RI18HC-G	GLASS	1/4							
	RI18HC-HG	HALF GLASS	2/5							
	RI18HC-HGS	HALF GLASS HALF SOLID	2/5							

*Depth measurement includes handles. For total height, add 3 or 6 inches, based on your mounting choice*

**REFRIGERATORS (PASS-THRU)**

MAINTAINS PRODUCT TEMPERATURES OF 36-38°F.

SECTIONS	MODEL #	DOOR TYPE	DOORS/SHELVES	WIDTH	DEPTH	HEIGHT	VOLTS	HP	AMPS	CUBIC FEET
1 SECTION	RID18HC-HS	HALF SOLID	2/5	27.25	32.63	69	115	1/4	5.5	18.38
	RID18HC-HGS	HALF GLASS HALF SOLID	4/5							

*Depth measurement includes handles. For total height, add 3 or 6 inches, based on your mounting choice*

**AVAILABLE DOORS**

- Solid (*one full-door*)
- Half Solid (*two half-doors*)
- Glass (*one full-door*)
- Half Glass (*two half-doors*)
- Half Glass, Half Solid (*two half-doors*)

**EXTERIOR FINISHES**

- Stainless steel

**INTERIOR FINISHES**

- Stainless steel

**AVAILABLE OPTIONS**

- Left hinge doors

**AVAILABLE ACCESSORIES**

- Additional shelves
- Wire shelf divider
- Bottle cartridge kit

**MOUNTING OPTIONS**

- 6" casters (standard)
- 6" legs
- 3" casters
- Flanged/seismic feet

**AGENCY CERTIFICATIONS**



# Bottom Mount Reach-In Accessories

DESCRIPTION	UNIT(S)	PART NUMBER
<b>SHELVING / ORGANIZERS</b>		
Epoxy Coated Wire Shelf	RB/FB/HBR/HBF23	403-900D-02
Epoxy Coated Wire Shelf	RB/FB/HBR/HBF27	403-871D-02
Epoxy Coated Wire Shelf	RB/FB/HBR/HBF49	403-873D-02
Epoxy Coated Wire Shelf	RB/FB/HBR/HBF72	403-874D-02
Epoxy Coated Wire Shelf	SR1 / SF1	100185005
Epoxy Coated Wire Shelf	SR2 / SF2	100185306
Epoxy Coated Wire Shelf	RI18	403-207D
Shelf Clip	RB/FB/HBR/HBF	403-169A
Shelf Clip	Any Slate Units	100389004
Flat Wine Rack with Bottle Support	RB/HBR23	403-928D-04
Flat Wine Rack with Bottle Support	RB/HBR27	403-929D-04
Flat Wine Rack with Bottle Support	RB/HBR49	403-930D-04
Flat Wine Rack with Bottle Support	RB/HBR72	403-931D-04
Wire Divider	RI Series	403-719C
<b>MOUNTING</b>		
3" Caster Kit	RB/FB/HBR/HBF	61C01-018D-01
6" Caster Kit	RB/FB/HBR/HBF	61C01-014D-01
6" Seismic/Flanged Legs	RB/FB/HBR/HBF Series (set of four)	00C31-055A
6" Caster	Any Slate Units	100476036
6" Caster With Brake	Any Slate Units	100476037
3" Caster	RI Series	401-695B
3" Caster With Brake	RI Series	401-696B
6" Caster	RI Series	401-275A
6" Caster With Brake	RI Series	401-276A
6" Black Legs	RI Series	401-405A
<b>ADDITIONAL ACCESSORIES</b>		
Door Lock (at time of order)	RB/FB/HBR/HBF (SOLID DOORS)	401-274A
<b>TRAY SLIDE KITS</b>		
<b>KIT #3 STAINLESS STEEL UNIVERSAL TRAY SLIDE</b>		
8 PAIRS PER 1/2 SECTION	RB/FB/HBR/HBF 23	61C08-038A-02 (order 2)
	RB/FB/HBR/HBF 49	61C08-038A-01 (order 4)







# WARMING CABINETS

KEEP FOOD WARM, FRESH, AND SAFE THROUGH THE PREP-TO-DELIVERY PROCESS



**NEW!**  
**Horizon Series**



**P Series**

# HORIZON® SERIES

## Warming Cabinets



# NEW

**Optimal airflow for consistent cabinet temperature**

**3 year parts and labor warranty**

**Made in USA**

### **Adjustable Electronic Temp Control**

From 80°F To 180°F

### **Built-In Adjustable Humidity Control Vent**

### **Safety Shielded Strip Type Heating Elements**

### **Externally Mounted Blower**

Maintains Even Temperatures

### **Stainless Steel Front**

With Gray Painted Galvanized Sides

### **Corrosion Resistant Aluminum Interior**

### **Stainless Steel Breaker Caps**

### **Snap-In Magnetic Door Gasket**

### **Heavy-Duty Cam Lift Hinges**

### **Stay-Open Door Feature**

For Easy Product Loading

### **3 Heavy-Duty Epoxy Coated Shelves**

per section



### **FULL ELECTRONIC CONTROL**

with easy to read digital display



### **FIELD-REVERSIBLE DOORS**

for flexibility to get your kitchen set up exactly how you want it



WARMING CABINETS

ADJUSTABLE ELECTRONIC TEMP CONTROL FROM 80°F TO 180°F

SECTIONS	MODEL #	DOOR TYPE	DOORS/SHELVES	WIDTH	DEPTH	HEIGHT	VOLTS	WATTS	AMPS	CUBIC FEET
1 SECTION	HH1-1S	SOLID	1/3	26	33.88	78.5	208-240	1500	5.9 / 6.8	21.17
2 SECTIONS	HH2-1S	SOLID	2/6	52	33.88	78.5	208-240	3000	11.3 / 13	45.04

Depth measurement includes handles. For total height, add 6 inches for casters.

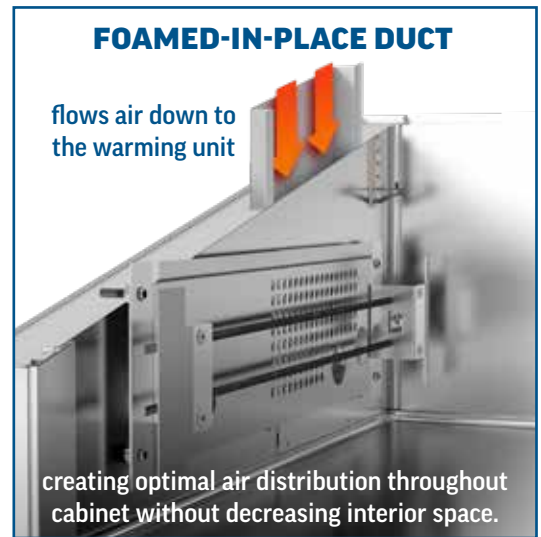

FOAMED-IN-PLACE DUCT

flows air down to the warming unit

creating optimal air distribution throughout cabinet without decreasing interior space.

Illustrated with the safety shield removed to give a good view of the heating element and vent.

AVAILABLE DOORS

- Solid (one full-door)

EXTERIOR FINISHES

- Stainless steel front with gray painted steel sides

INTERIOR FINISHES

- Corrosion resistant aluminum

AVAILABLE OPTIONS

- Left hinge doors

AVAILABLE ACCESSORIES

- Tray Slides
- Additional shelves

MOUNTING OPTIONS

- 6" casters (standard)
- 6" legs
- 3" casters
- Flanged/seismic feet

AGENCY CERTIFICATIONS





# P SERIES

## Spec Line Warming Cabinets



**Maximum resistance to wear and tear with stainless steel breaker caps and door liners**

**Modular interior gives maximum flexibility for shelf and slide combinations**

**3 Year parts and labor warranty**

**Stainless steel breakers**

**Full electronic control**

**Self-closing doors**

with 120° stay-open feature, on cam-lift hinges

**Built-in adjustable humidity control**

**Door locks standard**

for both Solid and Glass doors

**Magnetic gasket attached to each door**

for positive seal

**6" adjustable legs**

(3" casters or 6" caster option available at no charge when specified on order)

**3 chrome-plated wire shelves**

per section

**Removable access panel**

for ease of service and maintenance

**Temperature range from 80-180° F**



**AVAILABLE DOORS**

- Solid (one full-door)
- Half Solid (two half-doors)
- Glass (one full-door)
- Half Glass (two half-doors)



**EXTERIOR FINISHES**

- Stainless steel

**INTERIOR FINISHES**

- Corrosion-resistant aluminum
- Stainless steel

**AVAILABLE OPTIONS**

- Left hinge doors

**AVAILABLE ACCESSORIES**

- Additional shelves
- Tray slide kits (reach-in & pass-thru only)
- Stainless steel shelves
- Kick plate

**MOUNTING OPTIONS**

- 6" legs (standard)
- 6" casters
- 3" casters
- Flanged/seismic feet

**AGENCY CERTIFICATIONS**



**TRAY SLIDES A AVAILABLE**  
holds one 18x26" or two 14x18"



**TRAY SLIDES A/C AVAILABLE**  
hold one 18x26", or two 14x18", or two 12x20"

1, 2, AND 3 SECTION MODELS AVAILABLE IN REACH-IN, PASS-THRU, ROLL-IN, ROLL-THRU, AND EXTRA-TALL



# P SERIES

## WARMING CABINETS - REACH IN

TEMPERATURE RANGE FROM 80-180° F

SECTIONS	MODEL #	DOOR TYPE	DOORS/ SHELVES	WIDTH	DEPTH	HEIGHT	VOLTS	WATTS	AMPS	CUBIC FEET
1 SECTION	PH1-1S	SOLID	1/3	26.50	35	77.75	208-240	1500	6.3	21.5
	PH1-1HS	HALF SOLID	2/3	26.50	35	77.75	208-240	1500	6.3	21.5
	PH1-1BG	GLASS	1/3	26.50	33.38	77.75	208-240	1500	6.3	21.5
	PH1-1BHG	HALF GLASS	2/3	26.50	33.38	77.75	208-240	1500	6.3	21.5
2 SECTIONS	PH2-1S	SOLID	2/6	52.13	35	77.75	208-240	3000	13	46.5
	PH2-1HS	HALF SOLID	4/6	52.13	35	77.75	208-240	3000	13	46.5
	PH2-1BG	GLASS	2/6	52.13	33.38	77.75	208-240	3000	13	46.5
	PH2-1BHG	HALF GLASS	4/6	52.13	33.38	77.75	208-240	3000	13	46.5

Depth measurement includes handles. For total height, add 3 or 6 inches, based on your mounting choice.

## WARMING CABINETS - PASS-THRU

TEMPERATURE RANGE FROM 80-180° F

SECTIONS	MODEL #	DOOR TYPE	DOORS/ SHELVES	WIDTH	DEPTH	HEIGHT	VOLTS	WATTS	AMPS	CUBIC FEET
1 SECTION	PH1-1S-PT	SOLID	2/3	26.50	38.38	77.75	208-240	1500	6.3	21.5
	PH1-1HS-PT	HALF SOLID	4/3	26.50	38.38	77.75	208-240	1500	6.3	21.5
	PH1-1BG-PT	GLASS	2/3	26.50	35.88	77.75	208-240	1500	6.3	21.5
	PH1-1BHG-PT	HALF GLASS	4/3	26.50	35.88	77.75	208-240	1500	6.3	21.5
2 SECTIONS	PH2-1S-PT	SOLID	4/6	52.13	38.38	77.75	208-240	3000	13	46.5
	PH2-1HS-PT	HALF SOLID	8/6	52.13	38.38	77.75	208-240	3000	13	46.5
	PH2-1BG-PT	GLASS	4/6	52.13	35.88	77.75	208-240	3000	13	46.5
	PH2-1BHG-PT	HALF GLASS	8/6	52.13	35.88	77.75	208-240	3000	13	46.5

Depth measurement includes handles. For total height, add 3 or 6 inches, based on your mounting choice.

**WARMING CABINETS - ROLL-THRU**

TEMPERATURE RANGE FROM 80-180° F

SECTIONS	MODEL #	DOOR TYPE	DOORS	WIDTH	DEPTH	HEIGHT	VOLTS	WATTS	AMPS	CUBIC FEET
1 SECTION	PHI1-1S-PT	SOLID	2	36.5	39.88	84.38	208-240	1500	6.3	33.6
	PHI1XT-1S-PT					89.88				
2 SECTIONS	PHI2-1S-PT	SOLID	4	68.88	39.88	84.38	208-240	3000	13	72.4
	PHI2XT-1S-PT					89.88				

*Depth measurement includes handles.*

**WARMING CABINETS - ROLL-IN**

TEMPERATURE RANGE FROM 80-180° F

SECTIONS	MODEL #	DOOR TYPE	DOORS	WIDTH	DEPTH	HEIGHT	VOLTS	WATTS	AMPS	CUBIC FEET
1 SECTION	PHI1-1S	SOLID	1	36.5	36.13	84.38	208-240	1500	6.3	33.6
	PHI1XT-1S					89.88				
2 SECTIONS	PHI2-1S	SOLID	2	68.88	36.13	84.38	208-240	3000	13	72.4
	PHI2XT-1S					89.88				

*Depth measurement includes handles.*

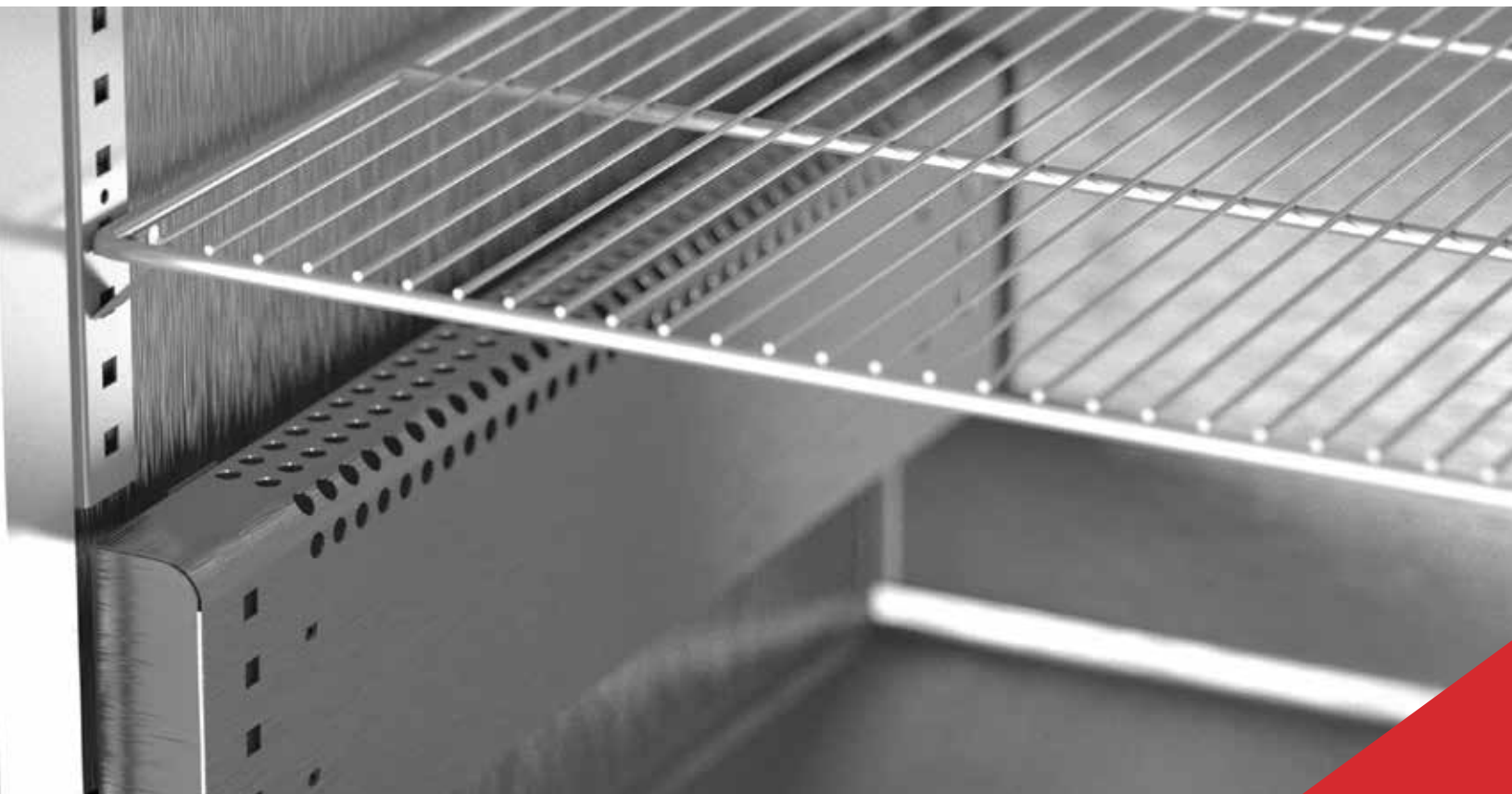

# Warming Cabinet Accessories

DESCRIPTION	UNIT(S)	PART NUMBER
<b>SHELVING / ORGANIZERS</b>		
Epoxy Coated Wire Shelf	H Series Flat Shelving 1 Door Unit	403-889D-01
Epoxy Coated Wire Shelf	H Series Flat Shelving 2 Door Unit	403-887D-01
Epoxy Coated Wire Shelf	P Series, 1 section	50597706
Epoxy Coated Wire Shelf	P Series, 2 section or 3 section (left or right)	50597806
Epoxy Coated Wire Shelf	P Series, 3 section (center)	50597906
Shelf Clip	Any H Series Unit	403-169A
Shelf Clip	P Series	50022601
<b>MOUNTING</b>		
6" Caster (set of four)	Any H Series Unit	61C01-001A
3" Caster (set of four)	Any H Series Unit	61C01-013A
6" Black Leg (set of four)	Any H Series Unit	58B02-001A
6" Seismic/Flanged Legs (set of four)	Any H Series Unit	00C31-055A
6" Casters (set of four)	P Series	0-0140-105S
3" Casters (set of four)	P Series	0-0140-103S
6" Seismic/Flanged Legs (set of four)	P Series	00C26-028A
<b>ADDITIONAL ACCESSORIES</b>		
Door lock	P Series	50597111



# Tray Slides

DESCRIPTION	UNIT(S)	PART NUMBER
-------------	---------	-------------

**INDIVIDUAL TRAY SLIDES**

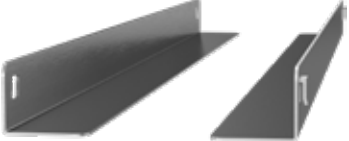
<b>1 pair of type "A" tray slides</b>	H-Series / P-Series	<b>10601211S</b>		
 <p><b>Pilaster and mounting hardware not included. Contact us for hardware selection.</b></p>	<b>Bottom support for (1) 18x26" pan, or (2) 14x18" pans</b>			
	<b>SPACING</b>	<b>2"</b>	<b>3"</b>	<b>4"</b>
	Full Door	26	18	13
	Half Door	12	8	6

<b>1 pair of type "A/C" tray slides</b>	H-Series	<b>10601201S</b>		
 <p><b>Pilaster and mounting hardware not included. Contact us for hardware selection.</b></p>	<b>Bottom support for (1) 18x26" pan, or (2) 14x18" pans, or (2) 12x20" pans</b>			
	<b>SPACING</b>	<b>2"</b>	<b>3"</b>	<b>4"</b>
	Full Door	26	18	13
	Half Door	12	8	6





# GLASS DOOR MERCHANDISERS

CONSISTENT COOLING POWER WITH WELL LIT PRODUCT DISPLAY



**Marketeer® Series**



**MarketMax Series**



**Countertop Models**



**Novelty & Dipping Cabinets**

# MARKETEER® SERIES

## Refrigerators & Freezers



**NEW SIZES  
AVAILABLE**

**Energy Star rated** (select models)

**Unique sizing options**

**3 year parts and labor warranty  
with an additional 4 year  
compressor part warranty**

**Triple pane Low-E argon-filled glass doors on  
freezers; Double pane on refrigerators**

### **LED lighting**

creates dynamic product presentation

**Refrigerators have electro-mechanical control**

**Freezers have full electronic control**

**Energy efficient and environmentally  
friendly R290 refrigerant**

(except for 1H6 models, which use R600)

### **Energy Star rated**

(select models)

### **Self-closing hinged doors**

with mechanical locks standard (except MT06, MT21, MT41)

### **Sliding glass doors available**

on select units

**NEW! Bottle Coolers now available** (MT41)



### **MECHANICAL LOCKS**

standard on all hinged units  
(excluding MT21 models)



### **BUILT-IN LED LIGHTS**

for dynamic product presentation

REFRIGERATORS

SECTIONS	MODEL #	DOOR TYPE	DOORS/SHELVES	WIDTH	DEPTH	HEIGHT	VOLTS	HP	AMPS	CUBIC FEET	COLOR
1 DOOR	MT08-1H6B	HINGED	1/5	18.88	20.63	71.38	115	1/8	1.8	7.69	BLACK
	MT08-1H6W										WHITE
<b>NEW</b> 1 DOOR	MT06-1H6B	HINGED	1/3	21.25	27.75	36.25	115	1/8	2.5	5.0	BLACK
1 DOOR	MT10-1B	HINGED	1/3	24.88	22.5	54.38	115	1/6	3.2	9.43	BLACK
	MT10-1W										WHITE
1 DOOR	MT12-1B	HINGED	1/4	24.88	22.81	63.63	115	1/6	4.1	11.5	BLACK
	MT12-1W										WHITE
1 DOOR	MT23-1B	HINGED	1/5	29.56	26.13	78.63	115	1/3	7	19.2	BLACK
	MT23-1W										WHITE
2 CURVED DOORS	MT21-1B	HINGED	2/10	36.13	24.5	57.5	115	1/3	3.6	16.8	BLACK
	MT21-1W										WHITE
2 DOORS	MT34-1B	HINGED	2/10	39.5	27.5	79	115	1/3	7.6	26.12	BLACK
	MT34-1W										WHITE
<b>NEW</b> 2 DOORS	MT41-48-1-SDB	SLIDING	2/6	47.25	21.75	48.13	115	1/4	3.1	16.4	BLACK
<b>NEW</b> 2 DOORS	MT41-54-1-SDB	SLIDING	2/6	47.25	21.75	54.13	115	1/4	3.1	19.5	BLACK
2 DOORS	MT49-1B	HINGED	2/10	47.13	30.13	79	115	1/2	8.3	37.42	BLACK
	MT49-1W										WHITE
2 DOORS	MT49-1-SDB	SLIDING	2/10	47.13	30.13	78.63	115	1/2	8.3	39.03	BLACK
	MT49-1-SDW *										WHITE
2 DOORS	MT53-1B	HINGED	2/10	54.25	29.38	79	115	1/2	8.3	41.66	BLACK
	MT53-1W										WHITE
2 DOORS	MT53-1-SDB	SLIDING	2/10	54.25	29.38	78.63	115	1/2	8.7	41.66	BLACK
	MT53-1-SDW *										WHITE
<b>NEW</b> 3 DOORS	MT72-1B	HINGED	3/15	78.75	33.63	79.38	115	2X 1/2	13.6	66.3	BLACK

\*Sliding glass doors and door frames are black on black exterior and white exterior units. / Depth measurement includes handles.

FREEZERS

SECTIONS	MODEL #	DOOR TYPE	DOORS/SHELVES	WIDTH	DEPTH	HEIGHT	VOLTS	HP	AMPS	CUBIC FEET	COLOR
<b>NEW</b> 1 DOOR	MTF12-1B	HINGED	1/4	24.88	22.81	63.63	115	1/2	5.1	11.5	BLACK
<b>NEW</b> 1 DOOR	MTF23-1B	HINGED	1/5	30.13	30.88	78.75	115	3/4	7.0	20.24	BLACK
<b>NEW</b> 2 DOORS	MTF53-1B	HINGED	2/10	54.3	31.3	78.9	115	(2) 1/2	11.2	42.97	BLACK

Depth measurement includes handles.

EXTERIOR FINISHES

- Black
- White (not available on MTF's)

INTERIOR FINISHES

- White

AVAILABLE ACCESSORIES

- Visislide shelving kit
- Extra shelves & clips
- 3" Casters
- 2" Leveling Legs

AVAILABLE DOORS

- Hinged
- Sliding door

AGENCY CERTIFICATIONS



# MARKETMAX<sup>®</sup> SERIES

## Refrigerators & Freezers



**Energy efficient R290 provides solution for all environmental concerns**

**Designed to perform in high ambient conditions**

**Made in USA**

**Double pane, lowE argon-filled glass doors**

Freezers have triple pane

**Field-reversible (refrigerator only)**

Requires additional hardware kit

**Self-closing doors**

120° stay open feature

**LED lighting**

creates dynamic product presentation

**Brightly lit sign panel**

**Custom door decals and signage available**

**Full electronic temperature control**

**Energy efficient and environmentally friendly R290 refrigerant**

**5 epoxy coated wire shelves per section**

**1, 2 & 3 door model options available**

**Sliding glass doors available on select units**





**AVAILABLE DOORS**

- Hinged
- Sliding door

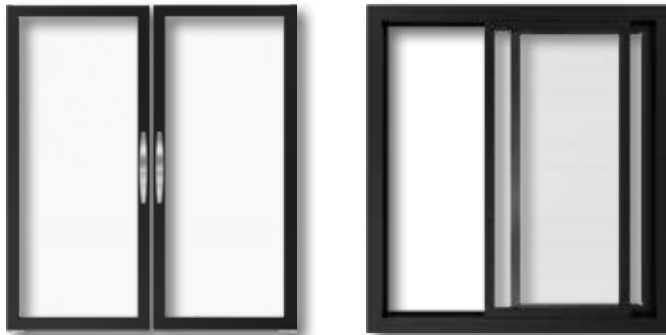

**EXTERIOR FINISHES**

- Black
- White
- Stainless steel

**INTERIOR FINISHES**

- Black
- White
- Stainless steel

**AVAILABLE OPTIONS**

- Left hinge doors
- Remote models available
- Header signs

**AVAILABLE ACCESSORIES**

- Electronic locks
- Dual-temp models
- Wine models
- Door locks
- Gravity-Flo kits
- Price-tag molding
- Custom graphics
- Field-reversible door kit (refrigerators only)

**MOUNTING OPTIONS**

- 6" casters
- 6" legs
- 3" casters

**AGENCY CERTIFICATIONS**



**FULL ELECTRONIC CONTROL**  
with easy to read digital display



**BRIGHTLY LIT HEADER PANEL**  
to grab attention and increase sales

**1, 2, AND 3 SECTION MODELS AVAILABLE**





# MARKETMAX<sup>®</sup>

## REFRIGERATORS

MAINTAINS PRODUCT TEMPERATURES OF 36-38°F.

SECTIONS	MODEL # BLACK	MODEL # WHITE	DOOR TYPE	DOORS/SHELVES	WIDTH	DEPTH	HEIGHT	VOLTS	HP	AMPS	CUBIC FEET
1	MMR12HC-1-B	MMR12HC-1-W	HINGED	1/4	24.13	25.75	62	115	1/6	2	12.06
1	MMR19HC-1-B	MMR19HC-1-W	HINGED	1/5	27.25	27.5	78	115	1/4	3	17.87
1	MMR23HC-1-B	MMR23HC-1-W	HINGED	1/5	27	33.63	78	115	1/4	3	23.1
1	MMR27HC-1-B	MMR27HC-1-W	HINGED	1/5	30	33.63	78	115	1/4	3	25.88
2	MMR35HC-1-B	MMR35HC-1-W	HINGED	2/10	39.5	33.5	78	115	1/4	2.4	36.87
2	MMR38HC-1-B	MMR38HC-1-W	SLIDING	2/10	43.5	32.25	78	115	1/3	5.4	35.37
2	MMR44HC-1-B	MMR44HC-1-W	HINGED	2/10	47	33.63	78	115	1/3	5.4	40.2
2	MMR45HC-1-B	MMR45HC-1-W	SLIDING	2/10	52	32.25	78	115	1/3	5.4	44
2	MMR49HC-1-B	MMR49HC-1-W	HINGED	2/10	52	33.63	78	115	1/3	5.4	46.15
3	MMR66HC-1-B	MMR66HC-1-W	SLIDING	3/15	75	32.25	78	115	1/2	6.2	64.4
3	MMR72HC-1-B	MMR72HC-1-W	HINGED	3/15	75	33.63	78	115	1/2	6.2	68.5

Depth measurement includes handles.

## FREEZERS

UTILIZES EXPANSION VALVE TECHNOLOGY TO MAINTAIN TEMPERATURE OF 0° TO -10°F.

SECTIONS	MODEL # BLACK	MODEL # WHITE	DOOR TYPE	DOORS/SHELVES	WIDTH	DEPTH	HEIGHT	VOLTS	HP	AMPS	CUBIC FEET
1	MMF12HC-1-B	MMF12HC-1-W	HINGED	1/4	24.13	25.75	62	115	1/2	5	11.9
1	MMF19HC-1-B	MMF19HC-1-W	HINGED	1/5	27.25	27.5	78	115	3/4	7.5	17.87
1	MMF23HC-1-B	MMF23HC-1-W	HINGED	1/5	27	33.63	78	115	3/4	7.5	22.5
1	MMF27HC-1-B	MMF27HC-1-W	HINGED	1/5	30	33.63	78	115	3/4	7.5	26.57
2	MMF35HC-1-B	MMF35HC-1-W	HINGED	2/10	39.5	33.5	78	115	3/4	11	36.87
2	MMF44HC-1-B	MMF44HC-1-W	HINGED	2/10	47	33.63	78	115	3/4	11	44
2	MMF49HC-1-B	MMF49HC-1-W	HINGED	2/10	52	33.63	78	115	3/4	11	46.2
3	MMF72HC-5-B	MMF72HC-5-W	HINGED	3/15	75	33.63	78	230*	3/4 (X2)	14	68.5

\*Freezers powered by 115/208-230 volts are designed for field wiring (requires 4-wire electrical circuit, hard-wired).

Depth measurement includes handles.

DUAL-TEMPS

MAINTAINS PRODUCT TEMPERATURES OF 36-38°F (REFRIGERATOR), AND -10°F (FREEZER).

SECTIONS	MODEL #	DOOR TYPE	DOORS/SHELVES	WIDTH	DEPTH	HEIGHT	VOLTS	HP	AMPS	CUBIC FEET	COLOR
2	MMRF49HC-1-A-BW	HINGED	2/10	52	33.63	78	115 (X2)	R: 1/4 F: 3/4	R: 2.4 F: 7.5	R: 21.01 F: 21.01	BLACK
	MMRF49HC-1-A-WW										WHITE
2	MMRR49HC-1-A-BW	HINGED	2/10	52	33.63	78	115 (X2)	R: 1/4 R: 1/4	R: 2.4 R: 2.4	R: 21.01 R: 21.01	BLACK
	MMRR49HC-1-A-WW										WHITE
3	MMRF72HC-1-B-BW	HINGED	3/15	75	33.63	78	115 (X2)	R: 1/4 F: 1	R: 2.4 F: 11	R: 19.62 F: 44.85	BLACK
	MMRF72HC-1-B-WW										WHITE
3	MMRR72HC-1-B-BW	HINGED	3/15	75	33.63	78	115 (X2)	R: 1/4 R: 1/4	R: 2.4 R: 2.4	R: 19.62 R: 44.85	BLACK
	MMRR72HC-1-B-WW										WHITE

\*Freezers powered by 115/208-230 volts are designed for field wiring (requires 4-wire electrical circuit, hard-wired).

Depth measurement includes handles.

All options for MarketMax Dual Temps are specified within the model number using the designated codes described below.

MMRF49HC EXAMPLE

Customer orders a MMRF49HC-1-A-BW

- Exterior will be black. Interior of the freezer AND the refrigerator will be white. (BW)
- The refrigerator will be on the LEFT with Left hinged door. The freezer will be on the RIGHT with Right hinged door. (RF)

MM (RF, FR) 49 - COOLER CONFIGURATIONS	
SINGLE DOOR ON LEFT - SINGLE DOOR ON RIGHT	
FR	Freezer on the Left with Left Hinged Door, Refrigerator on the Right with Right Hinged Door
RF	Refrigerator on the Left with Left Hinged Door, Freezer on the Right with Right Hinged Door
RR	One Refrigerator on the Left, second Refrigerator on Right
SPECIAL DOOR OPENINGS - ADD NUMBER TO END OF MODEL NUMBER	
-18	All Left Hinged Doors
-015	All Right Hinged Doors

MMRF72 EXAMPLE

Customer orders a MMRF72HC-1-B-WW

- Exterior will be white. Interior of the freezer AND the refrigerators will also be white. (WW)
- The refrigerator will be on the left and freezer will be on the right (RF)
- Single section on the left, and double section on the right (B)

MM (RF, FR) 72 - COOLER CONFIGURATIONS	
Refrigerator/Freezer Location	
FR	Freezer on the Left, Refrigerator on the right
RF	Refrigerator on the Left, Freezer on the right
RR	One Refrigerator on the Left, second Refrigerator on Right
Door Configuration	
B	Single section on left, Double section on right
C	Double section on left, Single section on right

COLOR COMBINATIONS	
(BOTH CABINET INTERIORS BEING THE SAME COLOR)	
BW	Black Exterior / White Interior
WW	White Exterior / White Interior
SW	Stainless Exterior / White Interior
BB	Black Exterior / Black Interior
BS	Black Exterior / Stainless Interior
WB	White Exterior / Black Interior
WS	White Exterior / Stainless Interior
SS	Stainless Exterior / Stainless Interior
SB	Stainless Exterior / Black Interior

B DOOR OPENINGS - ADD NUMBER TO END OF MODEL NUMBER	
	Standard - Single section on the Left with Left Hinged Door, 2 Door Section on the Right with Left/Right Hinged Doors
-282	Single section on the Left with Left Hinged Door, 2 Door Section on the Right with 2 Right Hinged Doors
-18	Single section on the Left with Left Hinged Door, 2 Door Section on the Right with 2 Left Hinged Doors
-015	Single section on the Left with Right Hinged Door, 2 Door Section on the Right with 2 Right Hinged Doors

C DOOR OPENINGS - ADD NUMBER TO END OF MODEL NUMBER	
	Standard - 2 Door Section on the Left with Left/Right Hinged Doors, Single Door Section on the Right with Right Hinged Door
-18	2 Door Section on the Left with 2 Left Hinged Doors, Single Door Section on the Right with Left Hinged Door
-015	2 Door Section on the Left with 2 Right Hinged Doors, Single Door Section on the Right with Right Hinged Door
-103	2 Door Section on the Left with 2 Left Hinged Doors, Single Door Section on the Right with Right Hinged Door

# MARKETMAX® IQ

## Merchandisers with **Electronic Smart Lock Feature**



**Keeps unattended merchandisers  
secure in your micro-market**

**Designed to perform in  
high ambient conditions**

**Made in USA**

### **Sleek design**

**NAMA certified, UL & NSF compliant**

**Secures temperature-sensitive  
products for worry-free operation**

**Automatically locks when power loss  
or temperature drop is sensed**

Unlocks automatically if outage is less than 30 minutes

**LED indicator to quickly view status**

Flashes to indicate if protection event occurs

**Easy-access test switch for health inspectors**

**Built-in safety feature allows escape in case of  
accidental lock-in**

Optional features such as remote monitoring, fault alerts, and remote unlocking can be added using [FreshTraq.com](http://FreshTraq.com)



**Detects power loss or  
temperature failure,  
and automatically  
locks the unit.**

## REFRIGERATORS

MAINTAINS PRODUCT TEMPERATURES OF 36-38°F.

SECTIONS	MODEL #	DOOR TYPE	DOORS/ SHELVES	WIDTH	DEPTH	HEIGHT	VOLTS	HP	AMPS	CUBIC FEET	COLOR
1	MMR12HC-1-B-IQ	HINGED	1/4	24.125*	25.75	62	115	1/6	2	12.06	BLACK
	MMR12HC-1-W-IQ										WHITE
1	MMR23HC-1-B-IQ	HINGED	1/5	27*	33.63	78	115	1/4	3	23.1	BLACK
	MMR23HC-1-W-IQ										WHITE
1	MMR27HC-1-B-IQ	HINGED	1/5	30*	33.63	78	115	1/4	3	25.88	BLACK
	MMR27HC-1-W-IQ										WHITE
2	MMR44HC-1-B-IQ	HINGED	2/10	47	33.63	78	115	1/3	5.4	40.2	BLACK
	MMR44HC-1-W-IQ										WHITE
2	MMR49HC-1-B-IQ	HINGED	2/10	52	33.63	78	115	1/3	5.4	46.15	BLACK
	MMR49HC-1-W-IQ										WHITE

\*The IQ locks on single door units are external and will add 1 inch to the overall width shown above.

Depth measurement includes handles.

## FREEZERS

UTILIZES EXPANSION VALVE TECHNOLOGY TO MAINTAIN TEMPERATURE OF 0° TO -10°F.

SECTIONS	MODEL #	DOOR TYPE	DOORS/ SHELVES	WIDTH	DEPTH	HEIGHT	VOLTS	HP	AMPS	CUBIC FEET	COLOR
1	MMF12HC-1-B-IQ	HINGED	1/4	24.125*	25.75	62	115	1/2	5	11.9	BLACK
	MMF12HC-1-W-IQ										WHITE
1	MMF23HC-1-B-IQ	HINGED	1/5	27*	33.63	78	115	3/4	7.5	22.5	BLACK
	MMF23HC-1-W-IQ										WHITE
1	MMF27HC-1-B-IQ	HINGED	1/5	30*	33.63	78	115	3/4	7.5	26.57	BLACK
	MMF27HC-1-W-IQ										WHITE
2	MMF44HC-1-B-IQ	HINGED	2/10	47	33.63	78	115	3/4	11	44	BLACK
	MMF44HC-1-W-IQ										WHITE
2	MMF49HC-1-B-IQ	HINGED	2/10	52	33.63	78	115	3/4	11	46.2	BLACK
	MMF49HC-1-W-IQ										WHITE

\*The IQ locks on single door units are external and will add 1 inch to the overall width shown above.

Depth measurement includes handles.

## AVAILABLE DOORS

- Hinged
- Sliding door

## EXTERIOR FINISHES

- Black
- White
- Stainless steel

## INTERIOR FINISHES

- Black
- White
- Stainless steel

## AVAILABLE OPTIONS

- Remote models available
- Header signs

## AVAILABLE ACCESSORIES

- Electronic locks
- Dual-temp models
- Wine models
- Gravity-Flo kits
- Price-tag molding
- Custom graphics

## MOUNTING OPTIONS

- 6" casters
- 6" legs
- 3" casters

## AGENCY CERTIFICATIONS



# MARKETMAX® WINE UNITS



standard MarketMax wine unit comes with standard doorlocks, wine thermostat, and five standard epoxy shelves

MarketMax wine unit with upgrades

**The MarketMax wine units have the same great MarketMax features, with wine-specific options to create the ultimate wine merchandiser.**

## SHELVING UPGRADES

We offer curved and flat wine racks, designed to secure the bottles while keeping them prominently on display. Available in white, black, and chrome finish.

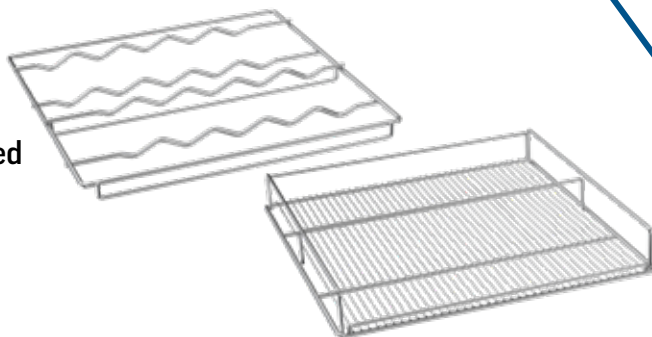

# BASE UNIT

# WINE OPTION UPGRADES

## WINE REFRIGERATORS



## SIGNAGE

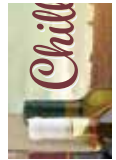

UNIT MODEL # (BLACK EXTERIOR - B)	W	D	H	FLAT RACK	CURVED SHELF		
MMR23HC-1-B-WINE	27	33.63	78	403-933D	412-076D	409-418C-065	409-418C-064
MMR27HC-1-B-WINE	30	33.63	78	403-934D	412-078D	409-419C-150	409-419C-149
MMR44HC-1-B-WINE	47	33.63	78	412-070D	412-074D	409-421C-080	409-421C-079
MMR49HC-1-B-WINE	52	33.63	78	403-936D	412-077D	409-422C-121	409-422C-120
MMR72HC-1-B-WINE	75	33.63	78	412-071D	412-073D	409-423C-070	409-423C-069

Depth measurement includes handles.

Add your shelf color choice to the end of the shelf model #  
 -01 for white; -02 for black; -04 for chrome finish  
 example: 412-078D-04



## SIGNAGE

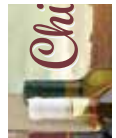

## DUAL-TEMP WINE REFRIGERATORS

## SHELVING

UNIT MODEL #	W	D	H	FLAT RACK	CURVED SHELF		
MMRR49HC-1-A-BW-WINE	52	33.63	78	412-072D	412-075D	409-422C-121	409-422C-120
MMRR72HC-1-B-BW-WINE	75	33.63	78	412-071D (double section) 412-070D (single section)	412-073D (double section) 412-074D (single section)	409-423C-070	409-423C-069

Depth measurement includes handles.

Add your shelf color choice to the end of the shelf model #  
 -01 for white; -02 for black; -04 for chrome finish  
 example: 412-075D-01

## CONTROLLER

Easily programmed to keep unit and its contents at the necessary set point (between 35-62° F)

To have your controller pre-programmed for white wines, change the WINE in the unit model number to WWINE; for red wines, change it to RWINE.



## FINISHES

MarketMax exterior is standard black with optional white or stainless steel.

MarketMax interior is standard white with optional black or stainless steel.





# COUNTERTOPS

## Refrigerators & Freezers



### MT06 Refrigerator

**NEW COUNTERTOP UNIT**

**Triple pane, Low-E argon-filled glass doors**

**Self-closing hinged door features pocket door handle**

**Refrigerators have electro-mechanical temperature control**

**LED lighting**  
creates dynamic product presentation

**Automatic, electric defrost**

**Freezers have full electronic control**

**R600 refrigerant**

**Energy Star rated**  
(select models)

**3 year parts & labor warranty / additional 4 year compressor warranty**

AGENCY CERTIFICATIONS



### CT96 Refrigerator

**Double pane, tempered glass door with locks**

**Heavy-duty black textured steel exterior**  
with black plastic door frames

**Heavy-duty white epoxy coated steel interior**

**LED lighting**  
creates dynamic product presentation

**3 epoxy coated shelves**  
top 2 shelves are adjustable

**Full electronic temperature control with display**

**Refrigeration system uses R600a refrigerant**  
to comply with all environmental concerns

**System is serviceable from the rear**

**Custom graphics available**

**1 year parts & labor warranty**

AGENCY CERTIFICATIONS



### REFRIGERATORS

MODEL #	DOORS/SHELVES	VOLTS	HP	AMPS	CUBIC FEET	WIDTH	DEPTH	HEIGHT	EXTERIOR COLOR	INTERIOR COLOR
MT06-1H6B	1/3	115	1/8	2.5	5	21.25	27.75	36.25	BLACK	WHITE
CT96HC-1-B	1/3	115	1/5	1.3	5.9	21.38	25.5	37.5	BLACK	WHITE

Depth measurement includes handles. Height measurement includes mounting height.



## CF3 Freezer

**Triple pane, tempered glass door**

**Pre-painted, steel interior and exterior**  
for easy cleaning

**LED lighting**  
creates dynamic product presentation

**2 shelves standard**  
one full & one half shelf

**Custom graphics available**

**AGENCY CERTIFICATIONS**



**2" leveling legs**  
with up to 1" for leveling of the unit

**Refrigeration system uses R290 refrigerant**  
to comply with all environmental concerns

**1 year parts & labor warranty**



## UCF20 Freezer

**Glass door provides clear merchandising of ice cream**

**Oversized refrigeration system holds -15°F product temperature**

**Full electronic control**  
for enhanced defrost



**AGENCY CERTIFICATIONS**



**Forced air design does not require unit to undergo manual defrost**  
which is a major advantage to comparable cold wall freezers

**20" footprint for countertop or undercounter applications**

**3 year parts and labor warranty / additional 4 year compressor warranty**

### FREEZERS

MODEL #	DOORS/SHELVES	VOLTS	HP	AMPS	CUBIC FEET	WIDTH	DEPTH	HEIGHT	COLOR	OPERATING TEMPERATURE
CF3HC-1-W	1/2	115	1/4	4	4	23.75	22.5	28.5	WHITE	-10° F
UCF20HC-25-15	1/2	115	1/2	3.65	2.25	20	24.5	31.13	STAINLESS	-10 to -15° F

*Depth measurement includes handles.*

**Energy efficient refrigerant provides solution for all environmental concerns**  
**Designed to perform in high ambient conditions**

# DIPPING CABINETS



**R290 refrigerant provides low energy consumption and is environmentally friendly**

**3 year parts and labor warranty with an additional 4 year compressor part warranty**

**Galvanized metal cabinet**

with powder coated painted surface

**Easy-to-clean interior**

**Full electronic control**

**Sliding glass lids are LowE tempered**

**Lock and keys standard**

**2" Heavy-duty casters**

allow easy and fast movement

**Drain plug for easy cleaning**

**Lexan sneeze guard**

**Heavy-duty PVC coated wire support racks**

allows containers to be placed on top level for optimal storage

**Each rack designed to hold**

multiple 3-gallon ice cream containers

**R290 refrigerant provides low energy consumption and is environmentally friendly**



**LID LOCKS STANDARD**

for loss prevention



**LED LIGHTING**

for dynamic product presentation

**DIPPING CABINETS**COLD WALL SYSTEM MAINTAINS  
TEMPERATURES OF 0 to -10°F.

MODEL #	WIDTH	DEPTH	HEIGHT	VOLTS	HP	AMPS	CUBIC FEET	COLOR
<b>BDC-HC-8</b>	<b>50.4</b>	<b>26.4</b>	<b>52</b>	120	1/3	5.4	15.2	White
<b>BDC-HC-12</b>	<b>68.2</b>	<b>26.4</b>	<b>52</b>	120	1/3	5.2	20.9	White

*Depth measurement includes handles. For total height, add 2 inches for the caster height.***BDC-HC-8 Capacity**

Top rack: eight 3-gallon ice cream containers  
 Bottom rack: six 3-gallon ice cream containers

**BDC-HC-12 Capacity**

Top rack: twelve 3-gallon ice cream containers  
 Bottom rack: ten 3-gallon ice cream containers

**EXTERIOR FINISHES**

- White

**INTERIOR FINISHES**

- White

**ACCESS OPTIONS**

- Glass lids

**MOUNTING OPTIONS**

- 2" casters (standard)

**AVAILABLE ACCESSORIES**

- Custom graphics

**AGENCY CERTIFICATIONS**

# NOVELTY CASES



**R290 refrigerant provides low energy consumption and is environmentally friendly**

**3 year parts and labor warranty with an additional 4 year compressor part warranty**

**White coated steel exterior**

**White powder coated surface interior**

**R290 refrigerant provides low energy consumption**

**LED lighting**

**Adjustable thermostat**

**Operating temperature of -10°F**

**Angle top design with LowE tempered glass lids**

**Lids are easily removable**

**Lid lock & keys**

**Round exterior edges**

**Integrated tag molding**

**2" heavy duty casters**

**Drain plug for easy cleaning**

**Removable baskets**



**LID LOCKS STANDARD**

for loss prevention



**LED LIGHTING**

for dynamic product presentation

**NOVELTY CASES**

MAINTAINS TEMPERATURES OF -10°F.

MODEL #	LIDS / BASKETS	WIDTH	DEPTH	HEIGHT	VOLTS	HP	AMPS	CUBIC FEET	COLOR
NC28HC-1-W	2/2	28.1	26.4	32.2	115	1/5	3	4.31	White
NC34HC-1-W	2/3	34.1	26.4	32.2	115	1/4	3	5.67	White
NC43HC-1-W	2/4	42.7	26.4	32.2	115	1/4	3.5	7.63	White
NC51HC-1-W	2/5	50.6	26.4	32.2	115	1/4	3.5	9.43	White
NC60HC-1-W	2/6	60.4	26.4	34.2	115	1/3	4	11.66	White
NC68HC-1-W	2/7	68.3	26.4	34.2	115	1/3	4	21	White

*Depth measurement includes handles. For total height, add 2 inches for the caster height.*

**EXTERIOR FINISHES**

- White

**INTERIOR FINISHES**

- White

**ACCESS OPTIONS**

- Glass lids

**MOUNTING OPTIONS**

- 2" casters (standard)

**AVAILABLE ACCESSORIES**

- Custom graphics
- Dip well

**AGENCY CERTIFICATIONS**



# Glass Door Merchandiser Accessories

DESCRIPTION	UNIT(S)	PART NUMBER
<b>SHELVING / ORGANIZERS</b>		
Epoxy Coated Wire Shelf	MMR/MMF23	<b>403-900D-01</b>
Epoxy Coated Wire Shelf	MMR/MMF27	<b>403-871D-01</b>
Epoxy Coated Wire Shelf	MMR/MMF49	<b>403-873D-01</b>
Epoxy Coated Wire Shelf	MMR/MMF72	<b>403-874D-01</b>
Epoxy Coated Wire Shelf, Black	MMR/MMF23	<b>403-900D-03</b>
Epoxy Coated Wire Shelf, Black	MMR/MMF27	<b>403-871D-03</b>
Epoxy Coated Wire Shelf, Black	MMR/MMF49	<b>403-873D-03</b>
Epoxy Coated Wire Shelf, Black	MMR/MMF72	<b>403-874D-03</b>
Wire Shelf	CT96	<b>CT9652</b>
FLAT Wine Rack	MMR23	<b>403-933D</b>
FLAT Wine Rack	MMR27	<b>403-934D</b>
FLAT Wine Rack	MMR44	<b>412-070D</b>
FLAT Wine Rack	MMR49	<b>403-936D</b>
FLAT Wine Rack	MMR72	<b>412-071D</b>
FLAT Wine Rack	MMRR49	<b>412-072D</b>
FLAT Wine Rack	MMRR72	<b>412-071D</b> (double section) <b>412-070D</b> (single section)
CURVED Wine Rack	MMR23	<b>412-076D</b>
CURVED Wine Rack	MMR27	<b>412-078D</b>
CURVED Wine Rack	MMR44	<b>412-074D</b>
CURVED Wine Rack	MMR49	<b>412-077D</b>
CURVED Wine Rack	MMR72	<b>412-073D</b>
CURVED Wine Rack	MMRR49	<b>412-072D</b>
CURVED Wine Rack	MMRR72	<b>412-073D</b> (double section) <b>412-074D</b> (single section)
Shelf Clip	MMR/MMF Series	<b>403-169A</b>
Novelty Basket (White)	All MMF models	<b>403-941D-01</b>
Novelty Basket (Black)	All MMF models	<b>403-941D-02</b>
Shelf Clip	CT96	<b>CT9651</b>
Gravity Flo Kits (5 shelves for 1 section)	MM23	<b>61C31-253D-01</b>
Gravity Flo Kits (5 shelves for 1 section)	MM27	<b>61C31-193A-01</b>
Gravity Flo Kits (5 shelves for 1 section)	MM44	<b>61C31-201A-01</b> (order 2)
Gravity Flo Kits (5 shelves for 1 section)	MM49/72	<b>61C31-199A-01</b> order 2 for MM49 order 3 for MM72
<b>MOUNTING</b>		
3" Casters	MT Series (set of four)	<b>61C01-011A</b>
2" Leveling Feet	MT Series (set of four)	<b>2016557</b>
6" Seismic/Flanged Legs	MMR/MMF Series (set of four)	<b>00C31-055A</b>
<b>ADDITIONAL ACCESSORIES</b>		
Door Lock	CT96	<b>61C11S043A</b>

Designate shelf color by adding one of these to the part number:

- 01 White
- 02 Black
- 04 Chrome Finish

ex. 412-078D-02

DESCRIPTION	UNIT(S)	PART NUMBER
<b>SIGNAGE</b>		
Price Tag Molding (per shelf)	MMR/F 23, 45/49, 66/72	<b>61A32-082D-01</b>
Price Tag Molding (per shelf)	MMR/F 27	<b>61A32-090D-02</b>
Price tag strips (5 p/kit)	MT08-1H6	<b>2039785</b>
Price tag strips (5 p/kit)	MT10-1	<b>2039789</b>
Price tag strips (5 p/kit)	MT23-1	<b>2039787</b>
Price tag strips (10 p/kit)	MT34-1	<b>2082716</b>
Price tag strips (10 p/kit)	MT49-1	<b>2082715</b>
Price tag strips (5 p/kit)	MT53-1	<b>2030792</b>
Brushed sign 26-3/8" x 8.5"	MMR23/MMF23	<b>409-505B-01</b>
Brushed sign 29 1/8" x 8.5"	MMR27/MMF27	<b>409-505B-02</b>
Brushed sign 46.13" W x 8.5"	MMR44/MMF44	<b>409-505B-04</b>
Brushed sign 51 1/8" x 8.5"	MMR/MMF49	<b>409-505B-05</b>
Brushed sign 74 1/4" x 8.5"	MMR/MMF72	<b>409-505B-06</b>
Flat Black Sign	MMR23/MMF23	<b>409-488B-01</b>
Flat Black Sign	MMR/MMF27	<b>409-488B-02</b>
Flat Black Sign	MMR/MMF49	<b>409-488B-05</b>
Flat Black Sign	MMR/MMF72	<b>409-488B-06</b>
Flat White Sign	MMR23/MMF23	<b>409-418C-053</b>
Flat White Sign	MMR/MMF27	<b>409-419C-140</b>
Flat White Sign	MMR/MMF49	<b>409-422C-109</b>
Flat White Sign	MMR/MMF72	<b>409-423C-061</b>
Self-Serve Sign	MMR23/MMF23	<b>409-418C-054</b>
Self-Serve Sign	MMR/MMF27	<b>409-419C-141</b>
Self-Serve Sign	MMR/MMF49/MMRF49	<b>409-422C-110</b>
Self-Serve Sign	MMR/MMF72/MMRF72	<b>409-423C-062</b>
Fresh Foods Sign	MMR23/MMF23	<b>409-418C-056</b>
Fresh Foods Sign	MMR/MMF27	<b>409-419C-143</b>
Fresh Foods Sign	MMR/MMF49	<b>409-422C-112</b>
Fresh Foods Sign	MMR/MMF72	<b>409-423C-064</b>
Cold Drinks Sign	MMR23	<b>409-418C-055</b>
Cold Drinks Sign	MMR27	<b>409-419C-142</b>
Cold Drinks Sign	MMR49	<b>409-422C-111</b>
Cold Drinks Sign	MMR72	<b>409-423C-063</b>
Chilled Wine Sign - Vineyard	MMR23	<b>409-418C-064</b>
Chilled Wine Sign - Vineyard	MMR27	<b>409-419C-149</b>
Chilled Wine Sign - Vineyard	MMR44	<b>409-421C-079</b>
Chilled Wine Sign - Vineyard	MMR49	<b>409-422C-120</b>
Chilled Wine Sign - Vineyard	MMR72	<b>409-423C-069</b>
Chilled Wine Sign - Corks	MMR23	<b>409-418C-065</b>
Chilled Wine Sign - Corks	MMR27	<b>409-419C-150</b>
Chilled Wine Sign - Corks	MMR44	<b>409-421C-080</b>
Chilled Wine Sign - Corks	MMR49	<b>409-422C-121</b>
Chilled Wine Sign - Corks	MMR72	<b>409-423C-070</b>
Got Milk Sign	MMR27	<b>409-419C-102</b>
Got Milk Sign	MMR 45/49	<b>409-422C-087</b>
Got Milk Sign	MMR 66/72	<b>409-423C-054</b>



Chilled Wine Sign - Vineyard



Chilled Wine Sign - Corks





# OPEN AIR MERCHANDISERS

EASY-ACCESS AND HIGH VISIBILITY PRODUCT DISPLAYS



**Breeze™ Series**



**VueMax™ Series**

# BREEZE™ SERIES



**Unique size suited for endcaps and schools**

**Custom graphics available**

**3 year parts and labor warranty with an additional 4 year compressor part warranty**

**Exterior finish is a heavy-duty steel**  
with a durable, baked on black or white coating

**Curved design with open front & side shield**  
to maximize product display

**Interior is white coated steel**

**2 recessed interior lights**  
provide maximum product visibility

**3 epoxy coated shelves**

**Modern grille is easy to remove**  
for cleaning or service

**Gravity-Flo organizer**

**Holds unit temperature from 32°-40°F**

**Certified for bottled beverage & packaged foods**

**Brightly lit sign panel**

**Featuring environmentally friendly energy-efficient R290 refrigerant**



**SIDE SHIELD**  
to maximize product display



**GRAVITY-FLO**  
organizer standard



**REFRIGERATORS**

MAINTAINS PRODUCT TEMPERATURES OF 32-40°F.

MODEL #	SHELVES	WIDTH	DEPTH	HEIGHT	VOLTS	HP	AMPS	CUBIC FEET	COLOR
BZ13HC-B	3	30	32.75	54.38	115	3/4	9.1	12.63	BLACK
BZ13HC-W									WHITE

*Depth measurement includes handles. For total height, add 2 inches for the caster height.*



**EXTERIOR FINISHES**

- Black
- White

**INTERIOR FINISHES**

- White

**AVAILABLE ACCESSORIES**

- Black dividers
- Black shelves
- Roller kit
- Custom graphics and signage

**AGENCY CERTIFICATIONS**





# VUEMAX™ SERIES



**Ideal for gourmet shops, delicatessens,  
convenience stores & bakeries**

**3 year parts and labor warranty  
with an additional 4 year  
compressor part warranty**

## **Heavy duty steel exterior**

with a durable paint finish

## **Glass sides enhance product visibility**

from side viewpoints

## **Foamed in place CFC-free polyurethane**

insulation enhances the structural strength of the cabinet and increases energy efficiency

## **LED lighting**

enhances product illumination for maximum visibility

## **Shelving display flexibility**

Shelves can be installed in two positions

## **Full electronic temperature control**

from 36° -40°F, with display

## **Certified for bottled beverage & packaged foods**

## **Night curtain**

## **Stylish impact bumper**

**Featuring environmentally friendly  
energy-efficient R290 refrigerant**



## **SIDE SHIELD**

to maximize product display



## **CUSTOM GRAPHICS AVAILABLE**

for brand or product promotion



**REGULAR DEPTH**

MAINTAINS PRODUCT TEMPERATURES OF 36-38°F.

MODEL #	SHELVES	WIDTH	DEPTH	HEIGHT	VOLTS	HP	AMPS	CUBIC FEET
VMHC-7-1	3	35.5	31.75	63.88	115	1/3	10	9.58
VMHC-12-1	5	35.13	31.75	83.13	115	(2) 1/4	12	15.45
VMHC-18-1	5	52	31.75	83.38	115	(2) 1/3	12	23.87

*Height measurements include 6 inch legs.*



**NARROW DEPTH**

MAINTAINS PRODUCT TEMPERATURES OF 36-38°F.

MODEL #	SHELVES	WIDTH	DEPTH	HEIGHT	VOLTS	HP	AMPS	CUBIC FEET
VMHCSL-18	5	47.3	24.38	83.5	115	2 (1/3)	12	23

*Height measurements include 6 inch legs.*

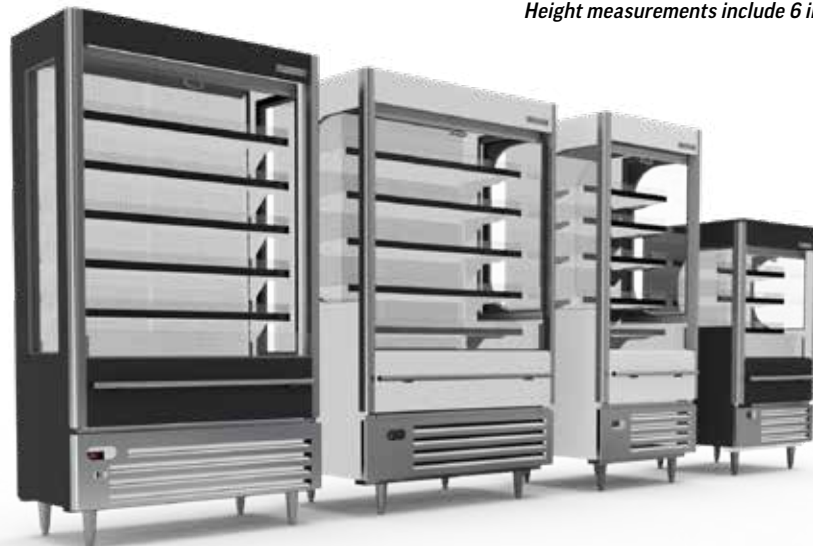

**EXTERIOR FINISHES**

- Black wrap over stainless steel
- White wrap over stainless steel
- Grey painted stainless steel

**INTERIOR FINISHES**

- White

**AVAILABLE ACCESSORIES**

- Lockable Security Cage
- Bar/bag hooks
- Price tag molding
- Clearcool Curtain
- Custom graphics available

**MOUNTING OPTIONS**

- 6" adjustable legs (standard)
- 5" casters

**AGENCY CERTIFICATIONS**



# Open Air Merchandiser Accessories

DESCRIPTION	UNIT(S)	PART NUMBER
<b>SHELVING / ORGANIZERS</b>		
Epoxy Coated Wire Shelf	BZ13	403-749D-01
Shelf Clip	BZ13	403-168A
Divider, 20oz	BZ13	403-750D-01

<b>MOUNTING</b>		
2" Roller Kit	BZ13	61C01-010A
5" Casters (set of 4)	VM7/VM12/VM18/VM18SL	61C01-014D-01

<b>MERCHANDISING ACCESSORIES</b>		
Front Product Display	VM7 / VM12	183602102
Front Product Display	VM18	183602101
Front Product Display	VM18 Slim	183602103
Side Saddle Bag Assembly (4 shelves)	VM7	183110203
Side Saddle Bag Assembly (7 shelves)	VM18	183110202
Clearcool Curtain Assembly, Plastic Strips	VM7	CLEARCOOL55
Clearcool Curtain Assembly, Plastic Strips	VM12	CLEARCOOL77
Clearcool Curtain Assembly, Plastic Strips	VM18	CLEARCOOL120
Wonder Bar Assembly, 48" Saddle Style Black w/6 Pegs	VM7 / VM12	WonderBar-ALPA-55/77
Wonder Bar Assembly, 48" Saddle Style Black w/6 Pegs	VM18 / VM18 Slim	WonderBar-ALPA-99/120

<b>ADDITIONAL ACCESSORIES</b>		
Locking Cage w/Lock	VM7	183629014ASM
Locking Cage w/Lock	VM12	183629013ASM
Locking Cage w/Lock	VM15	183629012ASM
Locking Cage w/Lock	VM18	183629011ASM
Locking Cage w/Lock	VM18 Slim	183629010

**Front Product Display**



**Wonder Bar**



**Product Stop**



**Casters**



**Saddle Bag**

Available for VM-7 (with 4 shelves), VM-12 (with 7 shelves), and VM-18 (with 7 shelves).

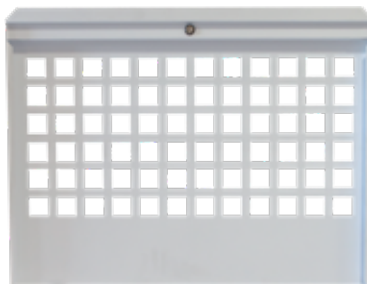

**Lockable Security Cage**



**Clearcool Curtain**









# DELI CASES

**BOLD AND SPACIOUS PRODUCT DISPLAY FOR ANY DELI OR BAKERY**





# DELI CASES

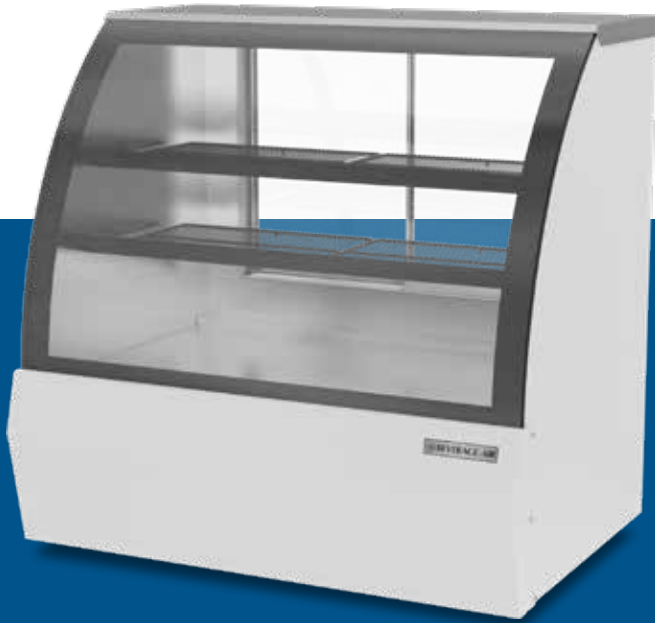

**Ideal for gourmet shops, bakeries, delicatessens and convenience stores**

**3 year parts and labor warranty with an additional 4 year compressor part warranty**

**Open-food rated**

**Sliding rear glass doors, easily removed for cleaning**

**Curved front glass**

**Full electronic control**

**LED lighting with on and off switch**

**Additional electrical outlet for scale**

**Adjustable shelves for better product display**

**Price tag molding standard**

**Powder coated galvanized steel exterior**

**Stainless steel floor with mirrored interior end caps**



## **ACCESSIBLE OUTLET**

Conveniently located for secondary small equipment such as scales.



## **REMOVABLE SLIDING DOORS**

for easy maintenance and cleaning of the unit and doors.

**REFRIGERATED UNITS**

MAINTAINS PRODUCT TEMPERATURES OF 33-41°F.

MODEL #	WIDTH	DEPTH	HEIGHT	VOLTS	HP	AMPS	CUBIC FEET	COLOR
CDR3HC-1-B	37.25	35.75	48.5	115	1/6	4	10	BLACK
CDR3HC-1-W								WHITE
CDR4HC-1-B	49.25	35.75	48.5	115	1/6	4	14	BLACK
CDR4HC-1-W								WHITE
CDR5HC-1-W	60.25	35.75	48.5	115	1/4	5	17	BLACK
CDR5HC-1-B								WHITE
CDR6HC-1-B	73.75	35.75	48.5	115	1/4	5	21	BLACK
CDR6HC-1-W								WHITE

Depth measurement includes handles. For total height, add 2 inches for the caster height.

**DRY CASES (NON-REFRIGERATED)**

MODEL #	WIDTH	DEPTH	HEIGHT	CUBIC FEET	COLOR
CDR3HC-1-B-D	37.25	35.75	48.5	10	BLACK
CDR3HC-1-W-D					WHITE
CDR4HC-1-B-D	49.25	35.75	48.5	14	BLACK
CDR4HC-1-W-D					WHITE
CDR5HC-1-W-D	60.25	35.75	48.5	17	BLACK
CDR5HC-1-B-D					WHITE
CDR6HC-1-B-D	73.75	35.75	48.5	21	BLACK
CDR6HC-1-W-D					WHITE

Depth measurement includes handles. For total height, add 2 inches for the caster height.

**EXTERIOR FINISHES**

- Black
- White

**INTERIOR FINISHES**

- Stainless steel floor with mirrored interior end caps

**AVAILABLE OPTIONS**

- Dry units

**MOUNTING OPTIONS**

- 3" casters
- 5" casters

**AGENCY CERTIFICATIONS**





# FOOD PREP TABLES

BACK BONE OF FOOD SERVICE WITH ALMOST LIMITLESS OPTIONS

**Sandwich Prep**



**Pizza Prep**



**Salad Bar**



# SANDWICH PREP

## Food Prep Tables



**Designed to perform in high ambient conditions**

**3 year parts and labor warranty with an additional 4 year compressor part warranty**

**Made in USA**

### **Full electronic control**

#### **Heavy-duty aluminum pan liner**

easy to clean and prevents spills from falling into cabinet while also ensuring coldest air flows across bottom of pans

#### **Reversible cutting boards**

1/2" thick, 10" deep

#### **Locking divider bars**

#### **Field-reversible doors**

with 120 degree stay-open feature

#### **Two epoxy coated shelves**

per door section standard

### **Snap-in door gaskets**

#### **Accommodates up to 6" deep food service pans**

4" deep 1/6 size polycarbonate pans are included

#### **Heavy duty insulated covers**

protects products and eliminates sweating when closed

#### **6" heavy duty casters standard**

3" casters or 6" leg option available at no charge when specified on order





**ACCESS OPTIONS**

- Doors
- Drawers
- Dual-sided

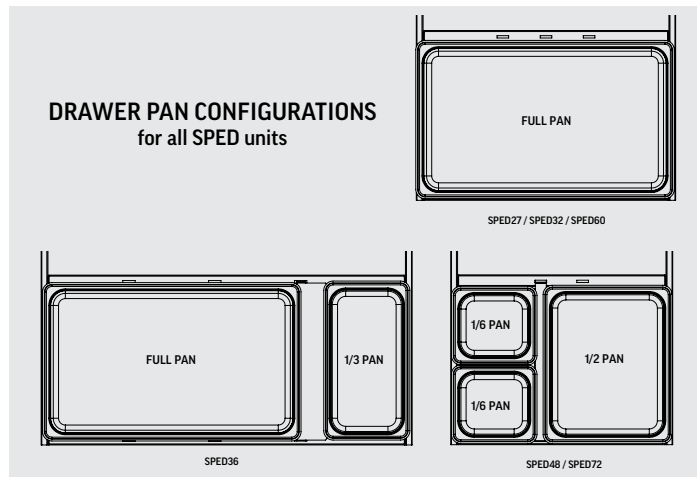

**EXTERIOR FINISHES**

- Stainless steel with galvanized back
- Stainless steel with stainless back

**INTERIOR FINISHES**

- Corrosion-resistant aluminum
- Stainless steel

**AVAILABLE OPTIONS**

- Left hinge doors
- Remote models available

**AVAILABLE ACCESSORIES**

- 12" crossbar
- Side/front crumb catchers
- Overshelf kits
- Composite cutting boards
- Bun tray rack
- Locks (for solid doors)

**LID OPTIONS**

(specify at time of order)

- Clear lids
- Flat-hinged lids
- Lift-off lids
- See-thru lids

**MOUNTING OPTIONS**

- 6" casters
- 3" casters (allows for ADA compliant working height)
- 6" legs

**AGENCY CERTIFICATIONS**



**PERFECT SEAL PAN LINER**  
ensures airflow under pans and protects bottom of cabinet from pan spills



**CLEAR LIDS AVAILABLE**  
for optimized product display

**AVAILABLE IN STANDARD TOP, MEGA TOP, AND CUTTING TOP**

**STANDARD TOP**

Two rows of food pans for easy access to ingredients. Perfect for smaller sandwich, salad or back of the house line service



**MEGA TOP**

Three rows of food pans offer 50% more capacity than a standard top prep table. Ideal for users with a wide array of ingredients



**CUT TOP**

An extra deep, 14" cutting board on a standard top unit offers additional workspace for larger item prep, catering or complicated menu items





# SANDWICH PREP

## AVAILABLE LID CHOICES

(specify at time of order)



### **ROLL TOP**

The standard lid for our sandwich prep units. A roll top lid allows for easy access and can be closed during non-service periods to allow the refrigeration system to recover.



### **FLAT-HINGED**

Durable lid helps to keep ingredients at food-safe temperature while the hinge locks the lid into place, allowing for easy access to the back row of pans.

**SEE-THRU**

Full glass, piston driven lid allows for easy view of ingredients and pan fill lines without removing the lid, and can act as a sneeze guard when optioned with a single overshelf and side guards.

**CLEAR**

A polycarbonate option that is ideal for operations that want to showcase their fresh ingredients to customers while keeping a lid on their pan section.

**LIFT-OFF**

Allows for full view of pan section and maximizes full use of work area. The low profile of lift off lids permits the unit to fit under existing shelving or service windows.

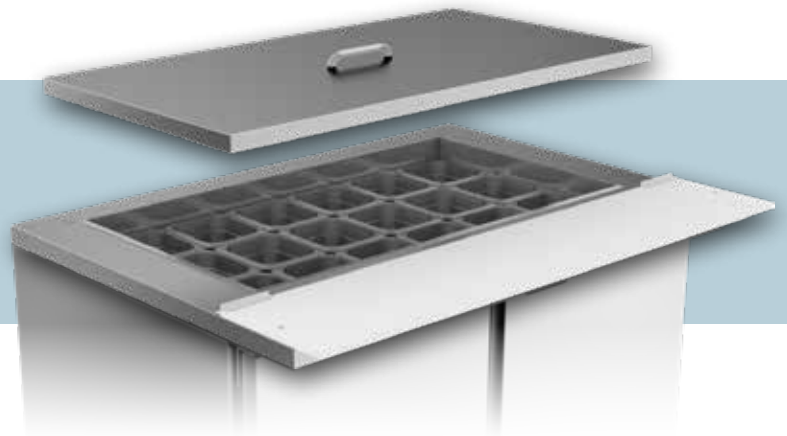

# SANDWICH PREP

## STANDARD TOP

MAINTAINS PRODUCT TEMPERATURES OF 36-38°F.

SECTIONS	MODEL #	DRAWERS	DOORS/ SHELVES	WIDTH	DEPTH	HEIGHT	VOLTS	HP	AMPS	CUBIC FEET	STANDARD PANS 4" DEEP
1	SPE27HC	–	1/2	27	32	39.25	115	1/6	2	6.91	(6) 1/6 size & (2) 1/9 size
	SPEED27HC	2	–								
1	SPE27HC-B	–	1/2	27	32	39.25	115	1/6	2	6.91	(8) 1/6 size
	SPEED27HC-B	2	–								
1	SPE32HC-08	–	1/2	32	32	39.25	115	1/6	2	8.01	(8) 1/6 size
	SPEED32HC-08-2	2	–								
2	SPE36HC-08	–	2/4	36	32	39.25	115	1/6	2	10.01	(8) 1/6 size
	SPEED36HC-08-2	2	–								
	SPE36HC-10	–	2/4	36	32	39.25	115	1/6	2	10.01	(10) 1/6 size
	SPEED36HC-10-2	2	–								
2	SPE48HC-08	–	2/4	48	32	39.25	115	1/6	2.2	13.01	(8) 1/6 size
	SPEED48HC-08-2	2	1/2								
	SPEED48HC-08-4	4	–								
	SPE48HC-10	–	2/4	48	32	39.25	115	1/6	2.2	13.01	(10) 1/6 size
	SPEED48HC-10-2	2	1/2								
	SPEED48HC-10-4	4	–								
	SPE48HC-12	–	2/4	48	32	39.25	115	1/6	2.2	13.01	(12) 1/6 size
	SPEED48HC-12-2	2	1/2								
SPEED48HC-12-4	4	–									
2	SPE60HC-08	–	2/4	60	32	39.25	115	1/3	5.4	16.02	(8) 1/6 size
	SPEED60HC-08-2	2	1/2								
	SPEED60HC-08-4	4	–								
	SPE60HC-10	–	2/4	60	32	39.25	115	1/3	5.4	16.02	(10) 1/6 size
	SPEED60HC-10-2	2	1/2								
	SPEED60HC-10-4	4	–								
	SPE60HC-12	–	2/4	60	32	39.25	115	1/3	5.4	16.02	(12) 1/6 size
	SPEED60HC-12-2	2	1/2								
	SPEED60HC-12-4	4	–								
	SPE60HC-16	–	2/4	60	32	39.25	115	1/3	5.4	16.02	(16) 1/6 size
	SPEED60HC-16-2	2	1/2								
	SPEED60HC-16-4	4	–								

For total height, add 3 or 6 inches, based on your mounting choice. Depth measurement includes handles and rear bumpers.

**STANDARD TOP**

MAINTAINS PRODUCT TEMPERATURES OF 36-38°F.

SECTIONS	MODEL #	DRAWERS	DOORS/SHELVES	WIDTH	DEPTH	HEIGHT	VOLTS	HP	AMPS	CUBIC FEET	STANDARD PANS 4" DEEP
3	SPE72HC-08	–	3/6	72	32	39.25	115	1/3	5.4	20.02	(8) 1/6 size
	SPED72HC-08-2	2	2/4								
	SPED72HC-08-4	4	1/2								
	SPED72HC-08-6	6	–								
	SPE72HC-10	–	3/6	72	32	39.25	115	1/3	5.4	20.02	(10) 1/6 size
	SPED72HC-10-2	2	2/4								
	SPED72HC-10-4	4	1/2								
	SPED72HC-10-6	6	–								
	SPE72HC-12	–	3/6	72	32	39.25	115	1/3	5.4	20.02	(12) 1/6 size
	SPED72HC-12-2	2	2/4								
	SPED72HC-12-4	4	1/2								
	SPED72HC-12-6	6	–								
SPE72HC-18	–	3/6	72	32	39.25	115	1/3	5.4	20.02	(18) 1/6 size	
SPED72HC-18-2	2	2/4									
SPED72HC-18-4	4	1/2									
SPED72HC-18-6	6	–									

For total height, add 3 or 6 inches, based on your mounting choice. Depth measurement includes handles and rear bumpers.

**CONDIMENT STATIONS WITH SNEEZEGUARD**

MAINTAINS PRODUCT TEMPERATURES OF 36-38°F.

SECTIONS	MODEL #	DRAWERS	DOORS/SHELVES	WIDTH	DEPTH	HEIGHT	VOLTS	HP	AMPS	CUBIC FEET	STANDARD PANS 4" DEEP
1	SPE27HC-SNZ	–	1/2	27	32	53	115	1/6	2	7.3	(6) 1/6 pans, (2) 1/9
2	SPE48HC-12-SNZ	–	2/4	48	32	53.13	115	1/6	2.2	13.9	(12) 1/6 pans

For total height, add 3 or 6 inches, based on your mounting choice. Depth measurement includes handles and rear bumpers.

# SANDWICH PREP

## MEGA TOP

MAINTAINS PRODUCT TEMPERATURES OF 36-38°F.

SECTIONS	MODEL #	DRAWERS	DOORS/ SHELVES	WIDTH	DEPTH	HEIGHT	VOLTS	HP	AMPS	CUBIC FEET	STANDARD PANS 4" DEEP
1	SPE27HC-12M	–	1/2	27	38.38	42.75	115	1/6	2	6.91	(9) 1/6 size & (3) 1/9 size
	SPED27HC-12M	2	–								
1	SPE27HC-12M-B	–	1/2	27	38.5	42.75	115	1/6	2	6.91	(12) 1/6 size
	SPED27HC-12M-B	2	–								
1	SPE32HC-12M	–	1/2	32	38.38	43	115	1/6	2	8.01	(12) 1/6 size
	SPED32HC-12M-2	2	–								
2	SPE36HC-12M	–	2/4	36	38.38	43	115	1/6	2	10.01	(12) 1/6 size
	SPED36HC-12M-2	2	–								
	SPE36HC-15M	–	2/4	36	38.38	43	115	1/6	2	10.01	(15) 1/6 size
	SPED36HC-15M-2	2	–								
2	SPE48HC-12M	–	2/4	48	38.38	43	115	1/6	2.2	13.01	(12) 1/6 size
	SPED48HC-12M-2	2	1/2								
	SPED48HC-12M-4	4	–								
	SPE48HC-18M	–	2/4	48	38.38	43	115	1/6	2.2	13.01	(18) 1/6 size
	SPED48HC-18M-2	2	1/2								
	SPED48HC-18M-4	4	–								
2	SPE60HC-12M	–	2/4	60	38.38	43	115	1/3	5.4	16.02	(12) 1/6 size
	SPED60HC-12M-2	2	1/2								
	SPED60HC-12M-4	4	–								
	SPE60HC-18M	–	2/4	60	38.38	43	115	1/3	5.4	16.02	(18) 1/6 size
	SPED60HC-18M-2	2	1/2								
	SPED60HC-18M-4	4	–								
	SPE60HC-24M	–	2/4	60	38.38	43	115	1/3	5.4	16.02	(24) 1/6 size
	SPED60HC-24M-2	2	1/2								
	SPED60HC-24M-4	4	–								

For total height, add 3 or 6 inches, based on your mounting choice. Depth measurement includes handles and rear bumpers.

**MEGA TOP**

MAINTAINS PRODUCT TEMPERATURES OF 36-38°F.

SECTIONS	MODEL #	DRAWERS	DOORS/ SHELVES	WIDTH	DEPTH	HEIGHT	VOLTS	HP	AMPS	CUBIC FEET	STANDARD PANS 4" DEEP
3	SPE72HC-12M	–	3/6	72	38.38	43	115	1/3	5.4	20.02	(12) 1/6 size
	SPED72HC-12M-2	2	2/4								
	SPED72HC-12M-4	4	1/2								
	SPED72HC-12M-6	6	–								
	SPE72HC-18M	–	3/6	72	38.38	43	115	1/3	5.4	20.02	(18) 1/6 size
	SPED72HC-18M-2	2	2/4								
	SPED72HC-18M-4	4	1/2								
	SPED72HC-18M-6	6	–								
	SPE72HC-24M	–	3/6	72	38.38	43	115	1/3	5.4	20.02	(24) 1/6 size
	SPED72HC-24M-2	2	2/4								
	SPED72HC-24M-4	4	1/2								
	SPED72HC-24M-6	6	–								
SPE72HC-30M	–	3/6	72	38.38	43	115	1/3	5.4	20.02	(30) 1/6 size	
SPED72HC-30M-2	2	2/4									
SPED72HC-30M-4	4	1/2									
SPED72HC-30M-6	6	–									

For total height, add 3 or 6 inches, based on your mounting choice. Depth measurement includes handles and rear bumpers.

**MEGA TOP – DUAL-SIDED**

SECTIONS	MODEL #	DOORS/ SHELVES	WIDTH	DEPTH	HEIGHT	VOLTS	HP	AMPS	CUBIC FEET	STANDARD PANS 4" DEEP
1	SPE27HC-12M-B-DS	2/2	27	48.75	40.75	115	1/6	2	6.91	(12) 1/6 size
2	SPE48HC-18M-DS	4/4	48	48.75	40.75	115	1/6	2.2	13.01	(18) 1/6 size
2	SPE60HC-24M-DS	4/4	60	48.75	40.75	115	1/3	5.4	16.02	(24) 1/6 size
3	SPE72HC-30M-DS	6/6	72	48.75	40.75	115	1/3	5.4	20.02	(30) 1/6 size

**MEGA TOP – SEE-THRU LIDS**

SECTIONS	MODEL #	DOORS/ SHELVES	WIDTH	DEPTH	HEIGHT	VOLTS	HP	AMPS	CUBIC FEET	STANDARD PANS 4" DEEP
2	SPE36HC-15M-STL	2/4	36	38.38	53.75	115	1/6	2	10.01	(15) 1/6 size
2	SPE48HC-18M-STL	2/4	48	38.38	53.75	115	1/6	2.2	13.01	(18) 1/6 size
2	SPE60HC-24M-STL	2/4	60	38.38	53.75	115	1/3	5.4	16.02	(24) 1/6 size
3	SPE72HC-30M-STL	3/6	72	38.38	53.75	115	1/3	5.4	20.02	(30) 1/6 size

For total height, add 3 or 6 inches, based on your mounting choice. Depth measurement includes handles and rear bumpers.



# SANDWICH PREP

**CUTTING TOP** (17" DEEP REVERSIBLE CUTTING BOARD)

MAINTAINS PRODUCT TEMPERATURES OF 36-38°F.

SECTIONS	MODEL #	DRAWERS	DOORS/ SHELVES	WIDTH	DEPTH	HEIGHT	VOLTS	HP	AMPS	CUBIC FEET	STANDARD PANS 4" DEEP
1	SPE27HC-C	–	1/2	27	38.38	39.25	115	1/6	2	6.91	(6) 1/6 size & (2) 1/9 size
	SPEED27HC-C	2	–								
1	SPE27HC-C-B	–	1/2	27	38.38	39.25	115	1/6	2	6.91	(8) 1/6 size
	SPEED27HC-C-B	2	–								
2	SPE36HC-08C	–	2/4	36	38.38	39.25	115	1/6	2	10.01	(8) 1/6 size
	SPEED36HC-08C-2	2	–								
	SPE36HC-10C	–	2/4	36	38.38	39.25	115	1/6	2	10.01	(10) 1/6 size
	SPEED36HC-10C-2	2	–								
2	SPE48HC-08C	–	2/4	48	38.38	39.25	115	1/6	2.2	13.01	(8) 1/6 size
	SPEED48HC-08C-2	2	1/2								
	SPEED48HC-08C-4	4	–								
	SPE48HC-10C	–	2/4	48	38.38	39.25	115	1/6	2.2	13.01	(10) 1/6 size
	SPEED48HC-10C-2	2	1/2								
	SPEED48HC-10C-4	4	–								
	SPE48HC-12C	–	2/4	48	38.38	39.25	115	1/6	2.2	13.01	(12) 1/6 size
	SPEED48HC-12C-2	2	1/2								
	SPEED48HC-12C-4	4	–								
2	SPE60HC-08C	–	2/4	60	38.38	39.25	115	1/3	5.4	16.02	(8) 1/6 size
	SPEED60HC-08C-2	2	1/2								
	SPEED60HC-08C-4	4	–								
	SPE60HC-10C	–	2/4	60	38.38	39.25	115	1/3	5.4	16.02	(10) 1/6 size
	SPEED60HC-10C-2	2	1/2								
	SPEED60HC-10C-4	4	–								
	SPE60HC-12C	–	2/4	60	38.38	39.25	115	1/3	5.4	16.02	(12) 1/6 size
	SPEED60HC-12C-2	2	1/2								
	SPEED60HC-12C-4	4	–								
	SPE60HC-16C	–	2/4	60	38.38	39.25	115	1/3	5.4	16.02	(16) 1/6 size
	SPEED60HC-16C-2	2	1/2								
	SPEED60HC-16C-4	4	–								

*For total height, add 3 or 6 inches, based on your mounting choice. Depth measurement includes handles and rear bumpers.*

**CUTTING TOP** (17" DEEP REVERSIBLE CUTTING BOARD)

MAINTAINS PRODUCT TEMPERATURES OF 36-38°F.

SECTIONS	MODEL #	DRAWERS	DOORS/ SHELVES	WIDTH	DEPTH	HEIGHT	VOLTS	HP	AMPS	CUBIC FEET	STANDARD PANS 4" DEEP
3	SPE72HC-08C	–	3/6	72	38.38	39.25	115	1/3	5.4	20.02	(8) 1/6 size
	SPED72HC-08C-2	2	2/4								
	SPED72HC-08C-4	4	1/2								
	SPED72HC-08C-6	6	–								
	SPE72HC-10C	–	3/6	72	38.38	39.25	115	1/3	5.4	20.02	(10) 1/6 size
	SPED72HC-10C-2	2	2/4								
	SPED72HC-10C-4	4	1/2								
	SPED72HC-10C-6	6	–								
	SPE72HC-12C	–	3/6	72	38.38	39.25	115	1/3	5.4	20.02	(12) 1/6 size
	SPED72HC-12C-2	2	2/4								
	SPED72HC-12C-4	4	1/2								
	SPED72HC-12C-6	6	–								
SPE72HC-18C	–	3/6	72	38.38	39.25	115	1/3	5.4	20.02	(18) 1/6 size	
SPED72HC-18C-2	2	2/4									
SPED72HC-18C-4	4	1/2									
SPED72HC-18C-6	6	–									

*For total height, add 3 or 6 inches, based on your mounting choice. Depth measurement includes handles and rear bumpers.*



# SANDWICH PREP

## Pan Configurations

### Standard Top

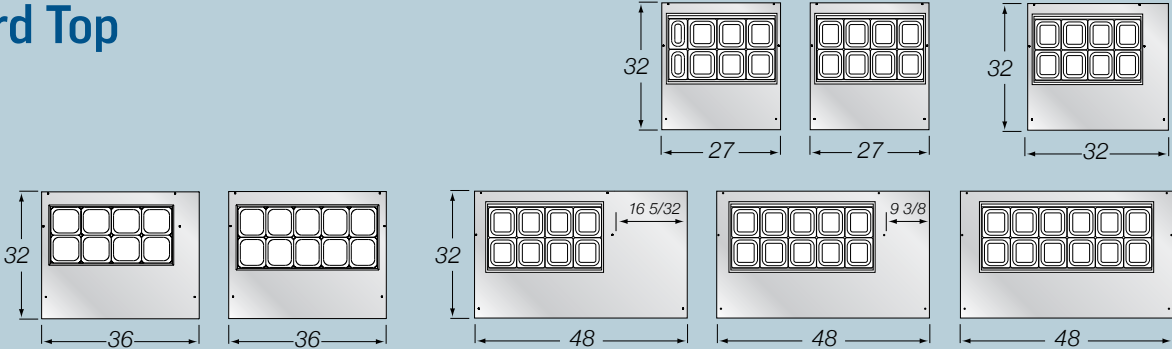

### Mega Top

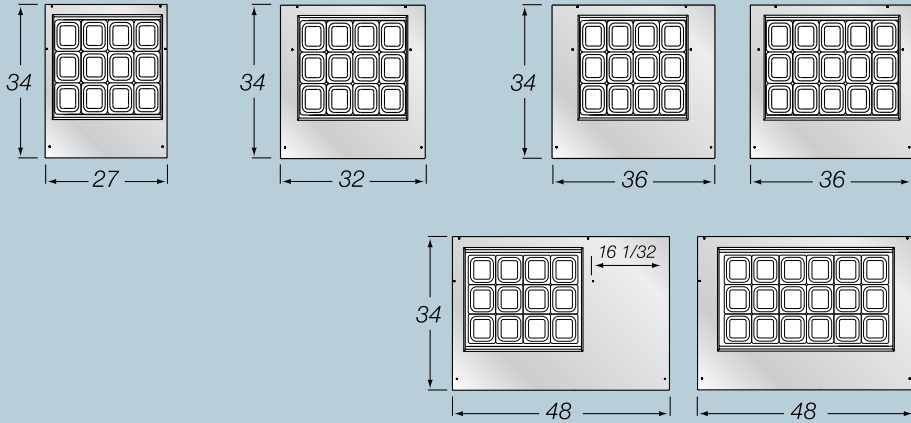

### Cutting Top

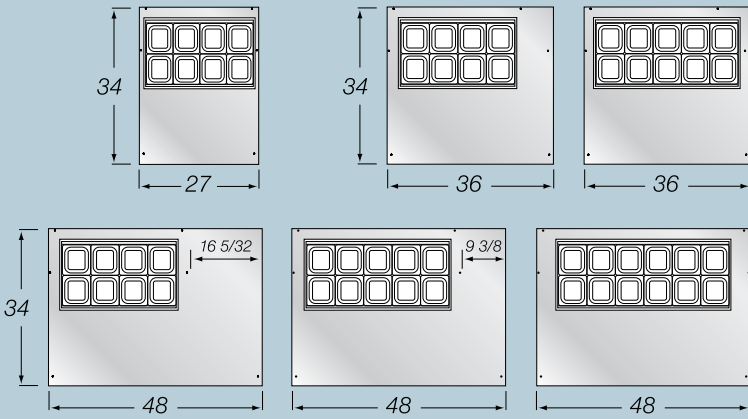

# Accommodates up to 6" deep food service pans

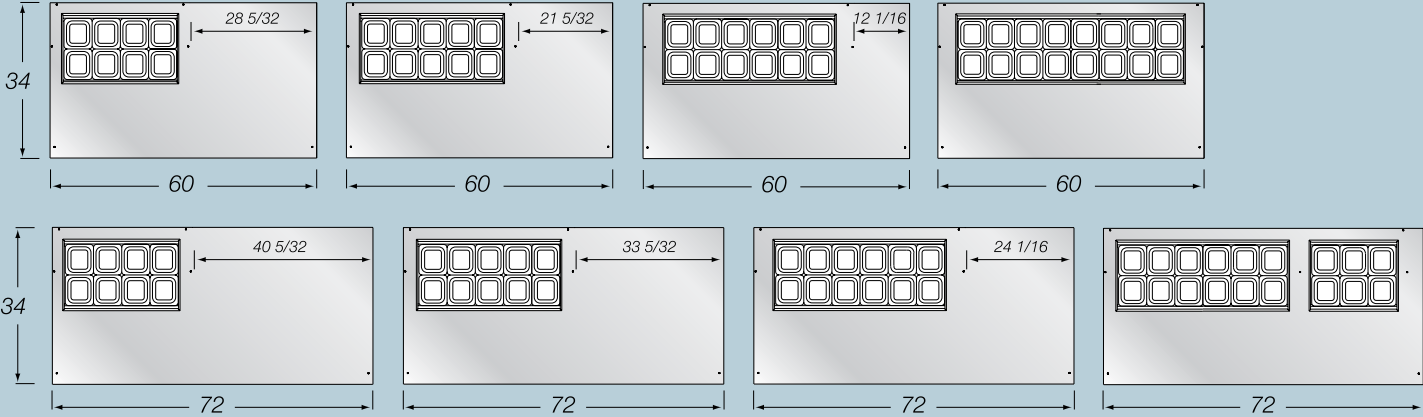
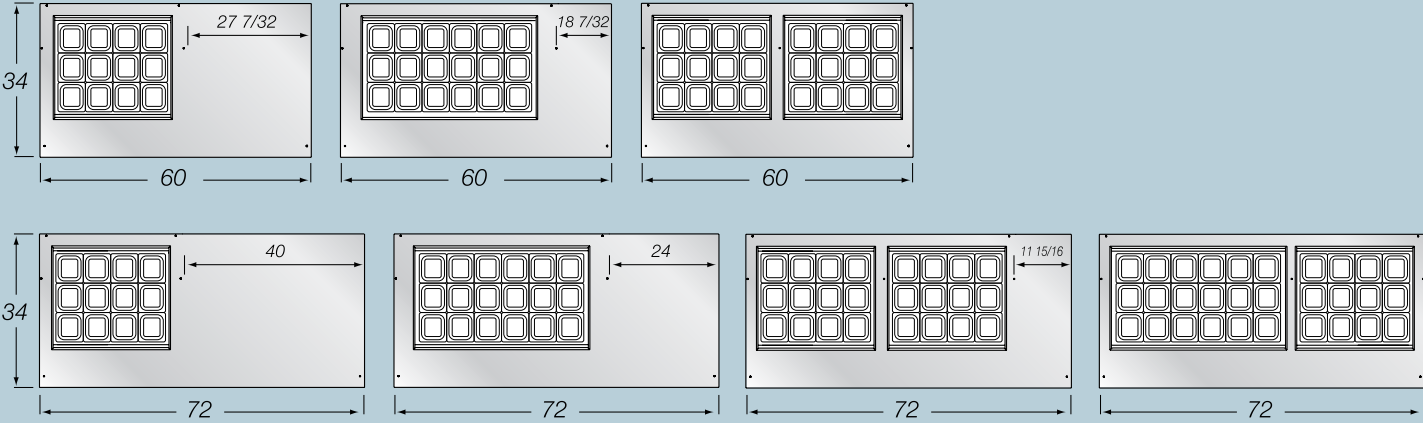
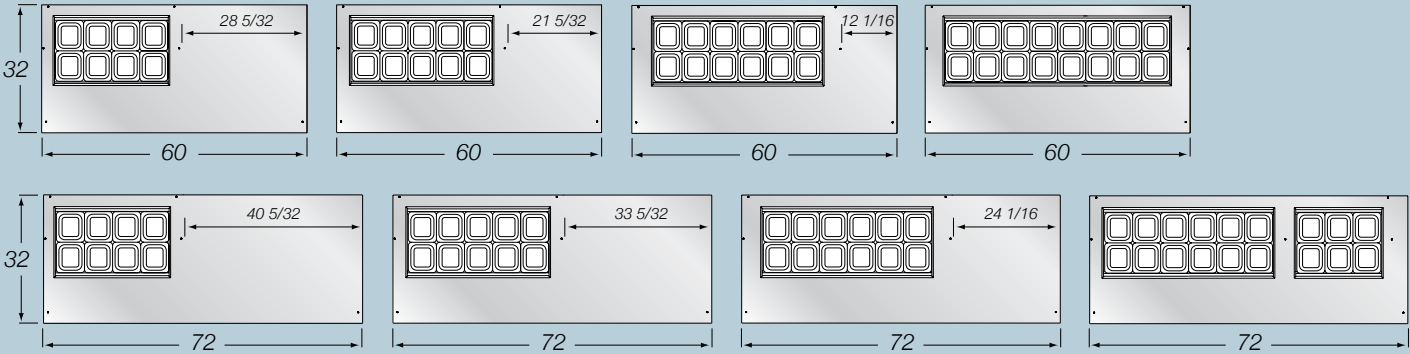

# PIZZA PREP

## Pizza & Deli Prep Tables



**Low-profile design for enhanced ergonomics and product display**

**Improved airflow maintains consistent pan temperature in top rail**

**Designed to perform in high ambient conditions**

**Duct system features uniform airflow distribution**

over evaporator coil and throughout raised rail

**Electronic controller with smart-defrost**

**12-Gauge stainless steel drawer slides with Delrin® rollers rated at 275 lbs**

**Electrical defrost heater**

terminates defrost sooner, reducing product instability

**Right or left compressor placement**

specify at time of order

**Field-reversible doors**

with 120 degree stay open feature

**Heavy-duty aluminum pan liner**

is easy to clean and prevents spills from falling into cabinet

**Accommodates up to 6" deep food service pans**

Not included

**Improved serviceability**

Removable service panel for easy access to refrigeration system

**Featuring environmentally friendly energy efficient R290 refrigerant**



**ACCESS OPTIONS**

- Doors
- Drawers (stacks of 2 or 3)

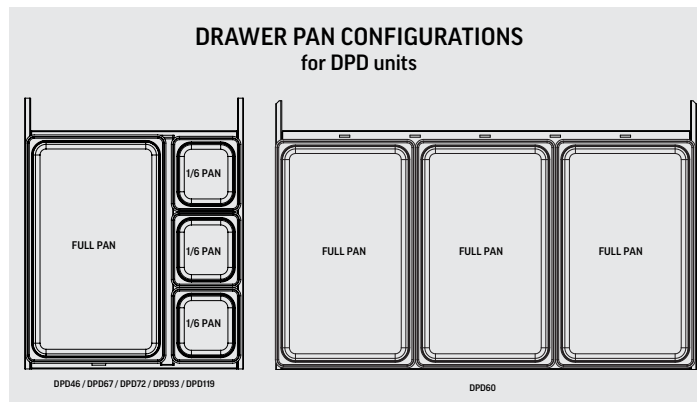

**EXTERIOR FINISHES**

- Stainless steel with galvanized back
- Stainless steel with stainless back

**INTERIOR FINISHES**

- Corrosion-resistant aluminum
- Stainless steel

**AVAILABLE OPTIONS**

- Left hinge doors
- Remote models available
- Alternate compressor locations

**AVAILABLE ACCESSORIES**

- Composite cutting boards
- Bun tray racks
- Overshelf
- Locks
- Additional shelves
- Pan slides (18x26)

**LID OPTIONS**

- Clear lids
- Flat Lift-off lids

**MOUNTING OPTIONS**

- 3" casters (standard)
- 6" casters
- 6" legs

**AGENCY CERTIFICATIONS**



**3 DRAWERS IN SINGLE SECTION**  
available on all sizes



**CLEAR LIDS AVAILABLE**  
for optimized product display





# PIZZA PREP

## PIZZA PREP

MAINTAINS PRODUCT TEMPERATURES OF 36-38°F.

SECTIONS	MODEL #	DRAWERS	DOORS/ SHELVES	WIDTH	DEPTH	HEIGHT	VOLTS	HP	AMPS	CUBIC FEET	FULL SIZE PAN CAPACITY
1	DP46HC	-	1/2	46	37	49.75	115	1/3	4.5	11.91	2
	DPD46HC-2	2	-								
	DPD46HC-3	3	-								
2	DP60HC	-	2/4	60	37	49.75	115	1/3	4.5	17	3 full pans & 1 half pan
	DPD60HC-2	2	-								
	DPD60HC-3	3	-								
2	DP67HC	-	2/4	67	37	49.75	115	1/3	4.5	20.68	3
	DPD67HC-2	2	1/2								
	DPD67HC-3	3	-								
	DPD67HC-4	4	-								
	DPD67HC-6	6	-								
2	DP72HC	-	2/4	72	37	49.75	115	1/3	4.5	21.87	3
	DPD72HC-2	2	1/2								
	DPD72HC-3	3	-								
	DPD72HC-4	4	-								
	DPD72HC-6	6	-								
3	DP93HC	-	3/6	93	37	49.75	115	1/2	7.8	31.54	4
	DPD93HC-2	2	2/4								
	DPD93HC-3	3	-								
	DPD93HC-4	4	1/2								
	DPD93HC-6	6	-								
4	DP119HC	-	4/8	119	37	49.75	115	1/2	7.8	42.2	5 full pans & 1 one-third pan
	DPD119HC-2	2	3/6								
	DPD119HC-3	3	3/6								
	DPD119HC-4	4	2/4								
	DPD119HC-6	6	1/2								
	DPD119HC-6T	6	2/4								
	DPD119HC-8	8	-								
	DPD119HC-9	9	1/2								

Depth measurement includes cutting board. For total height, add 3 or 6 inches, based on your mounting choice.

PAN CONFIGURATIONS  
for DP and DPD units

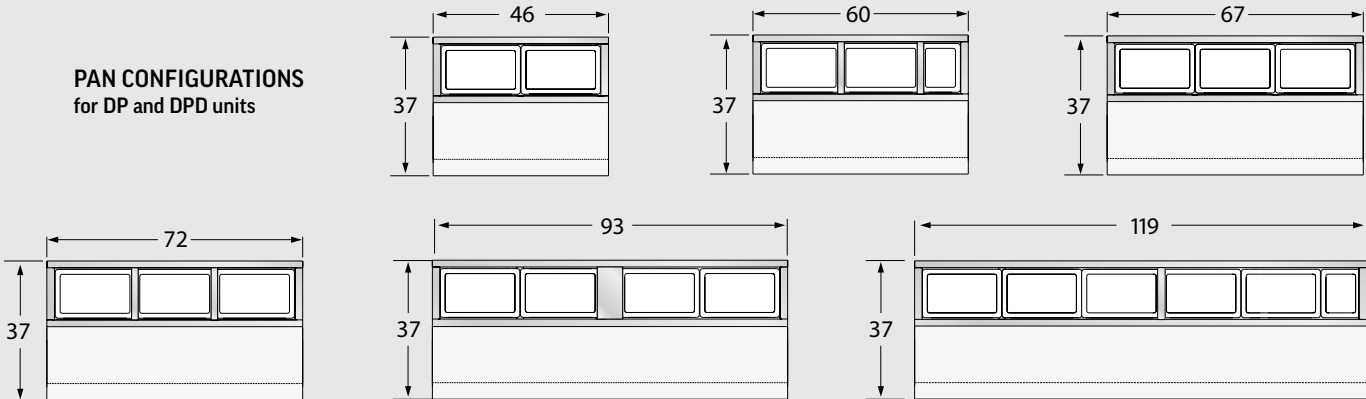

# SALAD BARS



**Designed to perform in high ambient conditions**

**3 year parts and labor warranty with an additional 4 year compressor part warranty**

**Made in USA**

## **Locking divider bars**

### **Lift-off lids standard**

to help maintain product temperature

### **Heavy-duty aluminum pan liner**

Easy to clean and prevents spills from falling into cabinet while also ensuring coldest air flows across bottom of pans

### **Field-reversible doors with 120 degree stay-open feature**

### **Two epoxy coated shelves**

per door section standard

### **Snap-in door gaskets**

### **Accommodates up to 6" deep food service pans**

### **4" deep 1/3 size polycarbonate pans are included**

### **6" heavy duty casters standard**

3" casters or 6" leg option available at no charge when specified on order



### **PERFECT SEAL PAN LINER**

ensures airflow under pans and protects bottom of cabinet from pan spills

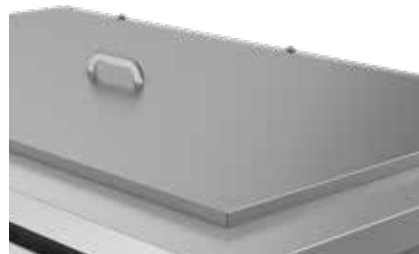

### **LIFT-OFF LIDS standard**

to help maintain product temperature

**SALAD BARS**

MAINTAINS PRODUCT TEMPERATURES OF 36-38°F.

MODEL #	DOORS/ SHELVES	WIDTH	DEPTH	HEIGHT	VOLTS	HP	AMPS	CUBIC FEET	STANDARD PANS 4" DEEP
<b>SPE36HC-S</b>	2/4	<b>36</b>	<b>30.13</b>	<b>30.88</b>	115	1/6	2	10	(6) 1/3 size
<b>SPE48HC-S</b>	2/4	<b>48</b>	<b>30.13</b>	<b>30.88</b>	115	1/6	2.2	13	(9) 1/3 size
<b>SPE60HC-S</b>	2/4	<b>60</b>	<b>30.13</b>	<b>30.88</b>	115	1/3	5.4	16	(12) 1/3 size
<b>SPE72HC-S</b>	3/6	<b>72</b>	<b>30.13</b>	<b>30.88</b>	115	1/3	5.4	20	(15) 1/3 size

*For total height, add 3 or 6 inches, based on your mounting choice. Depth measurement includes handles.*



**AVAILABLE ACCESSORIES**

- Foldable tray slides for single or dual-sided service
- Dual-sided sneeze guard, with optional add on for single side service

**ACCESS OPTIONS**

- Doors

**EXTERIOR FINISHES**

- Stainless steel with stainless back

**INTERIOR FINISHES**

- Corrosion-resistant aluminum
- Stainless steel

**LID OPTIONS**

- Lift-Off Lids

**AVAILABLE OPTIONS**

- Left hinge doors
- Remote models available

**MOUNTING OPTIONS**

- 6" casters
- 3" casters (allows for ADA compliant working height)
- 6" legs

**AVAILABLE ACCESSORIES**

- Foldable tray slides for single or dual-sided service
- Dual-sided sneeze guard, with optional add on for single side service
- Locks

**AGENCY CERTIFICATIONS**



# Food Prep Table Accessories

DESCRIPTION	UNIT(S)	PART NUMBER
<b>SHELVING / ORGANIZERS</b>		
Epoxy Coated Wire Shelf (Large)	SPE27/27-12M/27C	403-826B
Epoxy Coated Wire Shelf (Small)	SPE27/SPE27-12M/SPE27C	403-912D-01
Epoxy Coated Wire Shelf (Large)	SPE36/SPE36M/SPE36C	403-911D-01
Epoxy Coated Wire Shelf (Small)	SPE36/SPE36M/SPE36C	403-915D-01
Epoxy Coated Wire Shelf (Large)	SPE48/48M/48C	403-828B
Epoxy Coated Wire Shelf (Small)	SPE48/SPE48M/SPE48C	403-913D-01
Epoxy Coated Wire Shelf (Large)	SPE60/60M/60C	403-829B
Epoxy Coated Wire Shelf (Small)	SPE60/SPE60M/SPE60C	403-914D-01
Epoxy Coated Ctr Section Wire Shelf (Large)	SPE72/72M/72C	403-827B
Epoxy Coated Wire Shelf L&R (Large)	SPE72/72M/72C	403-828B
Epoxy Coated Ctr Section Wire Shelf (Small)	SPE72/SPE72M/SPE72C	403-912D-01
Epoxy Coated Wire Shelf L&R (Small)	SPE72/SPE72M/SPE72C	403-913D-01
Shelf Clip	All SPE/SPED/DP/DPD	403-169A
Large Wire Shelf Divider	SPE27	403-722C
Small Wire Shelf Divider	SPE27	403-721C
Large Wire Shelf Divider	SPE36	403-723C
Small Wire Shelf Divider	SPE36	403-721C
Large Wire Shelf Divider	SPE48	403-723C
Small Wire Shelf Divider	SPE48	403-721C
Large Wire Shelf Divider	SPE60	403-723C
Small Wire Shelf Divider	SPE60	403-721C
Large Wire Shelf Divider	SPE72	403-723C
Small Wire Shelf Divider	SPE72	403-721C
Bottle Organizer (Holds Qty. 10 Bottles) 16 oz.	SPE Mega Tops	00B23-023D-01
Bottle Organizer (Holds Qty. 10 Bottles) 24 oz.	SPE Mega Tops	00B23-024D-01
Bottle Organizer (Holds Qty. 8 Bottles) 16 oz.	SPE Standard & Cutting Tops	00B23-025D-01
Bottle Organizer (Holds Qty. 6 Bottles) 24 oz.	SPE Standard & Cutting Tops	00B23-026D-01
<b>CRUMBCATCHERS</b>		
Crumbcatcher Kit	SPE27A/SPE27B/SPE27MA/SPE27MB	00C23-071A-01
Crumbcatcher Kit	SPE36/36M	00C23-071A-09
Crumbcatcher Kit	SPE48/48M	00C23-071A-02
Crumbcatcher Kit	SPE60/60M	00C23-071A-03
Crumbcatcher Kit	SPE72/72M	00C23-071A-04
Crumbcatcher Kit	SPE27C	00C23-071A-05
Crumbcatcher Kit	SPE48C	00C23-071A-06
Crumbcatcher Kit	SPE60C	00C23-071A-07
Crumbcatcher Kit	SPE72C	00C23-071A-08
Side Crumbcatcher Kit	SPE Series	00C23-072A
<b>TRAY SLIDES &amp; PAN INSERTS</b>		
Pan Insert	SPE27A	00B23-032D-01
Pan Insert	SPE27B	00B32-033D-01

DESCRIPTION	UNIT(S)	PART NUMBER
<b>SPE WHITE POLY CUTTING BOARDS</b>		
10" Cutting Board	SPE27/27-12M, SPED27	705-290C-01
10" Cutting Board	SPE36/SPE36 MEGA/SPED36	705-290C-05
10" Cutting Board	SPE48/48M, SPED48	705-290C-02
10" Cutting Board	SPE60/60M, SPED60	705-290C-03
10" Cutting Board	SPE72/72M, SPED72	705-290C-04
17" Cutting Board	SPE27C, SPED27C	705-264C
17" Cutting Board	SPE32C, SPED32C	705-414D-02
17" Cutting Board	SPE36C/SPED36C	705-414D-01
17" Cutting Board	SPE48C, SPED48C	705-265C
17" Cutting Board	SPE60C, SPED60C	705-266C
17" Cutting Board	SPE72C, SPED72C	705-267C

<b>DP WHITE POLY CUTTING BOARDS (1/2" THICK)</b>		
19" Cutting Board	DP46	705-307C-01
19" Cutting Board	DP67	705-286B
19" Cutting Board	DP93	705-287B
19" Cutting Board	DP119	705-288B

<b>SPE COMPOSITE CUTTING BOARDS (1/2" THICK)</b>		
10" Composite Cutting Board	SPE27M	705-392D-06
17" Composite Cutting Board	SPE27C	705-392D-07
10" Composite Cutting Board	SPE36A	705-392D-15
10" Composite Cutting Board	SPE48	705-392D-04
12" Composite Cutting Board	SPE48	705-378B-01
15" Composite Cutting Board	SPE48C	705-392D-01
17" Composite Cutting Board	SPE48C	705-392D-08
10" Composite Cutting Board	SPE60	705-392D-05
15" Composite Cutting Board	SPE60C	705-392D-02
17" Composite Cutting Board	SPE60C	705-392D-09
10" Composite Cutting Board	SPE72	705-378B-02
17" Composite Cutting Board	SPE72C	705-392D-10

<b>DP COMPOSITE CUTTING BOARDS (1/2" THICK)</b>		
19" X 46" Composite Cutting Board	DP46	705-392D-11
19" X 67" Composite Cutting Board	DP67	705-392D-12
19" X 93" Composite Cutting Board	DP93	705-392D-13
19" X 119" Composite Cutting Board	DP119	705-392D-14



# Food Prep Table Accessories

DESCRIPTION	UNIT(S)	PART NUMBER
<b>OVERSHELVES</b>		
10" Single	SPE27	00C23S026A
10" Single	SPE36-08	00C23-074A-11
10" Single	SPE36-10	00C23-074A-12
10" Single	SPE48	00C23-027A
10" Single	SPE60	00C23-028A
10" Single	SPE72	00C23-029A
10" Double	SPE27	00C23-030A
10" Double	SPE36-08	00C23-075A-08
10" Double	SPE36-10	00C23-075A-09
10" Double	SPE48	00C23-031A
10" Double	SPE60	00C23-032A
10" Double	SPE72	00C23-033A
Single	SPE27-12M	00C23-074A-01
Single	SPE32-12M	00C23-074A-02
Single	SPE36-12M	00C23-074A-10
Single	SPE36-15M	00C23-074A-12
Single	SPE48/60/72-12M	00C23-074A-02
Single	SPE48-18M	00C23-074A-03
Single / For Dual-Sided	SPE48-18M-DS	00C23-105D
Single	SPE60-18M	00C23-074A-04
Single	SPE60-24M	00C23-074A-05
Single / For Dual-Sided	SPE60-24M-DS	00C23-106D
Single	SPE72-18M	00C23-074A-06
Single	SPE72-24M	00C23-074A-07
Single	SPE72-30M	00C23-074A-08
Single / For Dual-Sided	SPE72-30M-DS	00C23-093A
Double	SPE27-12M	00C23-030A
Double	SPE27-12M-B	00C23-075A-06
Double	SPE36-12M	00C23-075A-08
Double	SPE36-15M	00C23-075A-09
Double	SPE48-12M	00C23-075A-01
Double / For Dual-Sided	SPE48-18M-DS	00C23-107D-02
Double	SPE60-12M	00C23-075A-01
Double	SPE72-12M	00C23-075A-01
Double	SPE48-18M	00C23-075A-02
Double	SPE60-18M	00C23-075A-03
Double	SPE60-24M	00C23-075A-04
Double / For Dual-Sided	SPE60-24M-DS	00C23-107D-03
Double	SPE72-24M	00C23-032A
Double	SPE72-30M	00C23-075A-05
Double / For Dual-Sided	SPE72-30M-DS	00C23-107D-04
Single - 14" Deep	DP46	00C23-044A
Single - 14" Deep	DP60	00C23-161D-01
Single - 14" Deep	DP67	00C23-045A
Single - 14" Deep	DP72	00C23-161D-03
Single - 14" Deep	DP93	00C23-046A
Single - 14" Deep	DP119	00C23-161D-05

Clear-lid models (-CL) of SPE and SPED units cannot have an overshelf

DESCRIPTION	UNIT(S)	PART NUMBER
<b>OVERSHELVES CONT'D</b>		
Double - 14" Deep	DP46	00C23-119D-01
Double - 14" Deep	DP60	00C23-161D-02
Double - 14" Deep	DP67	00C23-116D-01
Double - 14" Deep	DP72	00C23-161D-04
Double - 14" Deep	DP93	00C23-120D-01
Double - 14" Deep	DP119	00C23-161D-06
Single - 14" Deep	SPE36-15M-STL	00C23-110D
Single - 14" Deep	SPE48-18M-STL	00C23-094D
Single - 14" Deep	SPE60-24M-STL	00C23-095D
Single - 14" Deep	SPE72-30M-STL	00C23-096D
Single - 14" Deep with side guards & LED light	SPE48-18M-STL	00C23-113D-01
Single - 14" Deep with side guards & LED light	SPE60-24M-STL	00C23-113D-02
Single - 14" Deep with side guards & LED light	SPE72-30M-STL	00C23-113D-03
Double - 10" Deep	SPE27 (will not work on B top)	00C23-123D-01
Double - 10" Deep	SPE36	00C23-124D-01
Double - 10" Deep	SPE48	00C23-125D-01
Double - 10" Deep	SPE60	00C23-126D-01
Double - 10" Deep	SPE72	00C23-127D-01
Double - 18" Deep	SPE27-M (will not fit on B top)	00C23-128D-01
Double - 18" Deep	SPE36-M	00C23-129D-01
Double - 18" Deep	SPE48-M	00C23-130D-01
Double - 18" Deep	SPE60-M	00C23-131D-01
Double - 18" Deep	SPE72-M	00C23-132D-01

*Clear-lid models (-CL) of SPE and SPED units cannot have an overshelf*

<b>ADDITIONAL ACCESSORIES</b>		
Door Lock	DP, SPE (per door)	00C30-099A

<b>MOUNTING</b>		
3" Caster	SPE units (set of four)	00C31-041A
6" Caster	SPE units (set of four)	00C31-038A
3" Caster	DP46,67,93 (set of four)	61C01-013A
6" Caster	DP46,67,93 (set of four)	61C01-001A
3" Caster	DP119 (set of six)	61C01-012A
6" Black Leg	SPE units ( set of four)	58B02-001A
6" Black Leg	DP46,67,93 ( set of four)	58B02-001A
6" Black Leg	DP119 (set of six)	58B02S002A
6" Seismic/Flanged Legs	SPE Series (set of four)	00C31-055A
6" Seismic/Flanged Legs	DP Series (set of four)	00C31-055A
2 3/4 in Caster Kit	Low Profile (set of four) SPE	00C31-049A
2" Roller Kit	SPE units	00C31-045A

# Food Prep Table Accessories

UNIT(S)		DESCRIPTION	PART NUMBER
---------	--	-------------	-------------

NIGHT COVERS FOR STANDARD PREP	COVERS REQUIRED	DESCRIPTION	PART NUMBER
SPE27HCHC	1	8 pan cover	00C32-013A-02
SPE32HCHC-08	1	8 pan cover	00C32-013A-06
SPE36HC-08	1	8 pan cover	00C32-013A-06
SPE36HC-10	1	10 pan cover	00C32-013A-07
SPE48HC-08	1	8 pan cover	00C32-013A-02
SPE48HC-10	1	10 pan cover	00C32-013A-03
SPE48HC-12	1	12 pan cover	00C32-013A-04
SPE60HC-08	1	8 pan cover	00C32-013A-02
SPE60HC-10	1	10 pan cover	00C32-013A-03
SPE60HC-12	1	12 pan cover	00C32-013A-04
SPE60HC-16	1	16 pan cover	00C32-013A-05
SPE72HC-08	1	8 pan cover	00C32-013A-02
SPE72HC-10	1	10 pan cover	00C32-013A-03
SPE72HC-12	1	12 pan cover	00C32-013A-04
SPE72HC-18	2	12 pan cover	00C32-013A-04
		6 pan cover	00C32-013A-01

NIGHT COVERS FOR MEGATOP PREP	COVERS REQUIRED	DESCRIPTION	PART NUMBER
SPE27HC-12M	1	12 pan cover	00C32-014A-03
SPE32HC-12M	1	12 pan cover	00C32-014A-01
SPE36HC-12M	1	12 pan cover	00C32-014A-01
SPE36HC-15M	1	15 pan cover	00C32-014A-04
SPE48HC-12M	1	12 pan cover	00C32-014A-01
SPE48HC-18M	1	18 pan cover	00C32-014A-02
SPE60HC-12M	1	12 pan cover	00C32-014A-01
SPE60HC-18M	1	18 pan cover	00C32-014A-02
SPE60HC-24M	2	12 pan cover (order two)	00C32-014A-01
SPE72HC-12M	1	12 pan cover	00C32-014A-01
SPE72HC-18M	1	18 pan cover	00C32-014A-02
SPE72HC-24M	2	12 pan cover (order two)	00C32-014A-01
SPE72HC-30M	2	12 pan cover	00C32-014A-01
		18 pan cover	00C32-014A-02

NIGHT COVERS FOR PIZZA PREP	COVERS REQUIRED	DESCRIPTION	PART NUMBER
DP46HC	1	full cover	00C32-017A-03
DP60HC	1	full cover	00C32-022D-04
DP67HC	1	full cover	00C32-022D-01
DP72HC	1	full cover	00C32-022D-03
DP93HC	2	section cover (order two)	00C32-017A-01
DP119HC	2	kit contains left and right covers	00C32-022D-02

DESCRIPTION	UNIT(S)	PART NUMBER
<b>SALAD BAR - SNEEZE GUARDS</b>		
Sneeze Guard	SPE36HC-S	00C23-160D-01
Sneeze Guard	SPE48HC-S	00C23-160D-02
Sneeze Guard	SPE60HC-S	00C23-160D-03
Sneeze Guard	SPE72HC-S	00C23-160D-04
<b>SALAD BAR - SNEEZE GUARD EXTENSION WALL FOR SINGLE SIDE SERVICE</b>		
Add-on wall for single side service	SPE36HC-S	00C23-162D-02
Add-on wall for single side service	SPE48HC-S	00C23-162D-03
Add-on wall for single side service	SPE60HC-S	00C23-162D-04
Add-on wall for single side service	SPE72HC-S	00C23-162D-05
<b>SALAD BAR - FOLDING TRAY SLIDES</b>		
Folding tray slide (order 2 for dual-side service)	SPE36HC-S	408-018D-36
Folding tray slide (order 2 for dual-side service)	SPE48HC-S	408-018D-48
Folding tray slide (order 2 for dual-side service)	SPE60HC-S	408-018D-60
Folding tray slide (order 2 for dual-side service)	SPE72HC-S	408-018D-72







# WORKTOPS & UNDERCOUNTERS

FOUNDATION OF KITCHEN LAYOUTS BUILT TO PERFORM

**Worktops**



**Undercounters**





# WORKTOPS

## Refrigerators & Freezers



**Designed to perform in high ambient conditions**

**3 year parts and labor warranty with an additional 4 year compressor part warranty**

**Made in USA**

**Stainless steel top**

**Full electronic control**

**Self-closing doors**

with 120° stay-open feature, on cartridge style hinges

**Magnetic gasket**

attached to each door for positive seal

**Featuring environmentally friendly energy efficient R290 refrigerant**

**Two epoxy-coated steel wire shelves per section**

**Field-reversible doors**

On select models

**6" heavy duty casters**

various ADA compliant mounting options



**DRAWER PAN CONFIGURATIONS**  
for WTRD and WTFD units

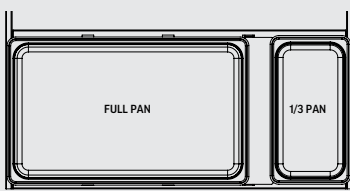

WTRD36 / WTFD36

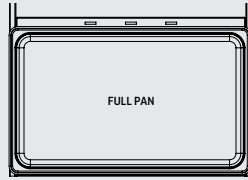

FULL PAN

WTRD27 / WTRD32 / WTRD60  
WTFD27 / WTFD32 / WTFD60

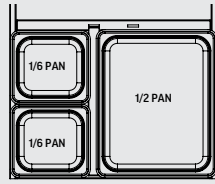

WTRD48 / WTRD72 / WTFD48

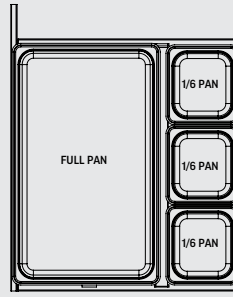

WTRD46 / WTRD67 / WTRD93 / WTRD119  
WTFD46 / WTFD67 / WTFD93 / WTFD119

**EXTERIOR FINISHES**

- Stainless steel with galvanized back
- Stainless steel with stainless back

**INTERIOR FINISHES**

- Corrosion-resistant aluminum
- Stainless steel

**AVAILABLE OPTIONS**

- Left hinge doors
- Remote models available

**AVAILABLE ACCESSORIES**

- Composite cutting boards (only available on rear-mounted worktops)
- Bun tray rack
- Door Locks (specify at time of order)
- Glass doors (rear-mount units only)
- 16-gauge stainless steel top

**BACKSPLASH OPTIONS**

- Removable
- 4" foamed-in-place
- Flat-top

**MOUNTING OPTIONS**

- 6" casters
- 3" casters
- 2.75" low-profile casters
- 1.25" roller-kit
- 6" legs

**AGENCY CERTIFICATIONS**



**REMOVABLE BACKSPLASH**  
available as an option, as well as a Flat Top, or a Foamed-in-Place backsplash



**FIELD-REVERSIBLE DOORS**  
for layout flexibility

**AVAILABLE IN REAR MOUNTED AND SIDE MOUNTED SYSTEMS, WITH SOLID OR GLASS DOORS**



# WORKTOPS

## Rear-Mounted Refrigeration

### REFRIGERATORS - REAR MOUNTED

MAINTAINS PRODUCT TEMPERATURES OF 36-38°F.

SECTIONS	MODEL #	DRAWERS	DOORS/ SHELVES	WIDTH	DEPTH	HEIGHT	VOLTS	HP	AMPS	CUBIC FEET	BACK SPLASH
1	WTR24AHC	-	1/2	24	32	33.63	115	1/6	2	5.16	REMOVABLE
	WTR24AHC-FIP			24	32	33.63	115	1/6	2	5.16	FOAM
	WTR24AHC-FLT			24	32	29.63	115	1/6	2	5.16	FLAT TOP
1	WTR27AHC	-	1/2	27	32	33.63	115	1/6	2	6.13	REMOVABLE
	WTRD27AHC-2	2	-								
1	WTR27AHC-FIP	-	1/2	27	32	33.63	115	1/6	2	6.13	FOAM
	WTRD27AHC-2-FIP	2	-								
1	WTR27AHC-FLT	-	1/2	27	32	29.63	115	1/6	2	6.13	FLAT TOP
	WTRD27AHC-2-FLT	2	-								
1	WTR32AHC	-	1/2	32	32	33.63	115	1/6	2	7.2	REMOVABLE
	WTRD32AHC-2	2	-								
1	WTR32AHC-FIP	-	1/2	32	32	33.63	115	1/6	2	7.2	FOAM
	WTRD32AHC-2-FIP	2	-								
1	WTR32AHC-FLT	-	1/2	32	32	29.63	115	1/6	2	7.2	FLAT TOP
	WTRD32AHC-2-FLT	2	-								
2	WTR36AHC	-	2/4	36	32	33.63	115	1/6	2	8.5	REMOVABLE
	WTRD36AHC-2	2	-								
2	WTR36AHC-FIP	-	2/4	36	32	33.63	115	1/6	2	8.5	FOAM
	WTRD36AHC-2-FIP	2	-								
2	WTR36AHC-FLT	-	2/4	36	32	29.63	115	1/6	2	8.5	FLAT TOP
	WTRD36AHC-2-FLT	2	-								
2	WTR48AHC	-	2/4	48	32	33.63	115	1/6	2.2	11.82	REMOVABLE
	WTRD48AHC-2	2	1/2								
	WTRD48AHC-4	4	-								
2	WTR48AHC-FIP	-	2/4	48	32	33.63	115	1/6	2.2	11.82	FOAM
	WTRD48AHC-2-FIP	2	1/2								
	WTRD48AHC-4-FIP	4	-								
2	WTR48AHC-FLT	-	2/4	48	32	29.63	115	1/6	2.2	11.82	FLAT TOP
	WTRD48AHC-2-FLT	2	1/2								
	WTRD48AHC-4-FLT	4	-								

For total height, add 3 or 6 inches, based on your mounting choice. Depth measurement includes handles and rear bumpers.

**REFRIGERATORS - REAR MOUNTED**

MAINTAINS PRODUCT TEMPERATURES OF 36-38°F.

SECTIONS	MODEL #	DRAWERS	DOORS/ SHELVES	WIDTH	DEPTH	HEIGHT	VOLTS	HP	AMPS	CUBIC FEET	BACK SPLASH
2	WTR60AHC	–	2/4	60	32	33.63	115	1/5	3	14.75	REMOVABLE
	WTRD60AHC-2	2	1/2								
	WTRD60AHC-4	4	–								
2	WTR60AHC-FIP	–	2/4	60	32	33.63	115	1/5	3	14.75	FOAM
	WTRD60AHC-2-FIP	2	1/2								
	WTRD60AHC-4-FIP	4	–								
2	WTR60AHC-FLT	–	2/4	60	32	29.63	115	1/5	3	14.75	FLAT TOP
	WTRD60AHC-2-FLT	2	1/2								
	WTRD60AHC-4-FLT	4	–								
3	WTR72AHC	–	3/6	72	32	33.63	115	1/5	3	17.88	REMOVABLE
	WTRD72AHC-2	2	2/4								
	WTRD72AHC-4	4	1/2								
	WTRD72AHC-6	6	–								
3	WTR72AHC-FIP	–	3/6	72	32	33.63	115	1/5	3	17.88	FOAM
	WTRD72AHC-2-FIP	2	2/4								
	WTRD72AHC-4-FIP	4	1/2								
	WTRD72AHC-6-FIP	6	–								
3	WTR72AHC-FLT	–	3/6	72	32	29.63	115	1/5	3	17.88	FLAT TOP
	WTRD72AHC-2-FLT	2	2/4								
	WTRD72AHC-4-FLT	4	1/2								
	WTRD72AHC-6-FLT	6	–								

For total height, add 3 or 6 inches, based on your mounting choice. Depth measurement includes handles and rear bumpers.

**BACKSPLASH OPTIONS**



**standard**  
Removable backsplash  
ex: *WTR48AHC*



**-FIP**  
4" foamed-in-place backsplash  
ex: *WTR48AHC-FIP*



**-FLT**  
Flat-top with no backsplash  
ex: *WTR48AHC-FLT*

# WORKTOPS

## Shallow Depth Refrigeration (Rear-Mounted)

### REFRIGERATORS (SHALLOW DEPTH)

MAINTAINS PRODUCT TEMPERATURES OF 36-38°F.

SECTIONS	MODEL #	DOORS/ SHELVES	WIDTH	DEPTH	HEIGHT	VOLTS	HP	AMPS	CUBIC FEET	BACK SPLASH
1	WTR20HC	1/2	20	24.5	30.13	115	1/6	2	2.34	REMOVABLE
	WTR20HC-FIP	1/2	20	24.5	30.13	115	1/6	2	2.34	FOAM
	WTR20HC-FLT	1/2	20	24.5	26.13	115	1/6	2	2.34	FLAT TOP
1	WTR27HC	1/2	27	29.88	33.63	115	1/6	2	5.25	REMOVABLE
	WTR27HC-FIP	1/2	27	29.88	33.63	115	1/6	2	5.25	FOAM
	WTR27HC-FLT	1/2	27	29.88	29.63	115	1/6	2	5.25	FLAT TOP
2	WTR34HC	2/4	34	24.63	30.13	115	1/6	2	3.88	REMOVABLE
	WTR34HC-FIP	2/4	34	24.63	30.13	115	1/6	2	3.88	FOAM
	WTR34HC-FLT	2/4	34	24.63	26.13	115	1/6	2	3.88	FLAT TOP

For total height, add 3 or 6 inches, based on your mounting choice. Depth measurement includes handles and rear bumpers.









# WORKTOPS

## Rear-Mounted Freezers

### FREEZERS - REAR MOUNTED

MAINTAINS PRODUCT TEMPERATURE AT 0° F AND BELOW.

SECTIONS	MODEL #	DRAWERS	DOORS/ SHELVES	WIDTH	DEPTH	HEIGHT	VOLTS	HP	AMPS	CUBIC FEET	BACK SPLASH
1	WTF24AHC	-	1/2	24	32	33.63	115	1/4	2.5	4.9	REMOVABLE
	WTF24AHC-FIP			24	32	33.63	115	1/4	2.5	4.9	FOAM
	WTF24AHC-FLT			24	32	29.63	115	1/4	2.5	4.9	FLAT TOP
1	WTF27AHC	-	1/2	27	32	33.63	115	1/4	2.5	6.13	REMOVABLE
	WTFD27AHC-2	2	-								
1	WTF27AHC-FIP	-	1/2	27	32	33.63	115	1/4	2.5	6.13	FOAM
	WTFD27AHC-2-FIP	2	-								
1	WTF27AHC-FLT	-	1/2	27	32	29.63	115	1/4	2.5	6.13	FLAT TOP
	WTFD27AHC-2-FLT	2	-								
1	WTF32AHC	-	1/2	32	32	33.63	115	1/3+	4	7.2	REMOVABLE
	WTFD32AHC-2	2	-								
1	WTF32AHC-FIP	-	1/2	32	32	33.63	115	1/3+	4	7.2	FOAM
	WTFD32AHC-2-FIP	2	-								
2	WTF32AHC-FLT	-	1/2	32	32	29.63	115	1/3+	4	7.2	FLAT TOP
	WTFD32AHC-2-FLT	2	-								
2	WTF36AHC	-	2/4	36	32	33.63	115	1/4	6	8.69	REMOVABLE
	WTFD36AHC-2	2	-								
2	WTF36AHC-FIP	-	2/4	36	32	33.63	115	1/4	6	8.69	FOAM
	WTFD36AHC-2-FIP	2	-								
2	WTF36AHC-FLT	-	2/4	36	32	33.63	115	1/4	6	8.69	FLAT TOP
	WTFD36AHC-2-FLT	2	-								

For total height, add 3 or 6 inches, based on your mounting choice. Depth measurement includes handles and rear bumpers.

**FREEZERS - REAR MOUNTED**

MAINTAINS PRODUCT TEMPERATURE AT 0° F AND BELOW.

SECTIONS	MODEL #	DRAWERS	DOORS/ SHELVES	WIDTH	DEPTH	HEIGHT	VOLTS	HP	AMPS	CUBIC FEET	BACK SPLASH
2	WTF48AHC	–	2/4	48	32	33.63	115	1/2	7	11.04	REMOVABLE
	WTFD48AHC-2	2	1/2								
	WTFD48AHC-4	4	–								
2	WTF48AHC-FIP	–	2/4	48	32	33.63	115	1/2	7	11.04	FOAM
	WTFD48AHC-2-FIP	2	1/2								
	WTFD48AHC-4-FIP	4	–								
2	WTF48AHC-FLT	–	2/4	48	32	29.63	115	1/2	7	11.04	FLAT TOP
	WTFD48AHC-2-FLT	2	1/2								
	WTFD48AHC-4-FLT	4	–								
2	WTF60AHC	–	2/4	60	32	33.63	115	1/2	7	14.39	REMOVABLE
	WTFD60AHC-2	2	1/2								
	WTFD60AHC-4	4	–								
2	WTF60AHC-FIP	–	2/4	60	32	33.63	115	1/2	7	14.39	FOAM
	WTFD60AHC-2-FIP	2	1/2								
	WTFD60AHC-4-FIP	4	–								
2	WTF60AHC-FLT	–	2/4	60	32	29.63	115	1/2	7	14.39	FLAT TOP
	WTFD60AHC-2-FLT	2	1/2								
	WTFD60AHC-4-FLT	4	–								

*For total height, add 3 or 6 inches, based on your mounting choice. Depth measurement includes handles and rear bumpers.*

# WORKTOPS

## Shallow Depth Freezers (Rear-Mounted)

### FREEZERS (SHALLOW DEPTH)

MAINTAINS PRODUCT TEMPERATURE AT 0° F AND BELOW.

SECTIONS	MODEL #	DOORS/SHELVES	WIDTH	DEPTH	HEIGHT	VOLTS	HP	AMPS	CUBIC FEET	BACK SPLASH
1	WTF20HC	1/2	20	24.5	30.13	115	1/4	2.5	2.34	REMOVABLE
	WTF20HC-FIP	1/2	20	24.5	30.13	115	1/4	2.5	2.34	FOAM
	WTF20HC-FLT	1/2	20	24.5	26.13	115	1/4	2.5	2.34	FLAT TOP
1	WTF27HC	1/2	27	29.88	33.63	115	1/4	2.5	5.25	REMOVABLE
	WTF27HC-FIP	1/2	27	29.88	33.63	115	1/4	2.5	5.25	FOAM
	WTF27HC-FLT	1/2	27	29.88	29.63	115	1/4	2.5	5.25	FLAT TOP

For total height, add 3 or 6 inches, based on your mounting choice. Depth measurement includes handles and rear bumpers.



WTR34HC-23-25

### ORDER YOUR UNIT TO YOUR SPECIFICATIONS WITH AVAILABLE OPTIONS SUCH AS:

#### GLASS DOORS (-25)

Increase visibility by swapping the solid doors with glass doors on select refrigerator and freezer models.

#### 3-INCH CASTERS (-23)

Lower the height of the unit for workflow or ADA compliance by selecting the 3-inch casters instead of the standard 6-inch ones.

## Rear-Mounted Dual-Temps

### DUAL-TEMPS

MAINTAINS PRODUCT TEMPERATURES OF 36-38°F (REFRIGERATOR), AND 0°F (FREEZER).

SECTIONS	MODEL #	DOORS/SHELVES	WIDTH	DEPTH	HEIGHT	VOLTS	HP	AMPS	CUBIC FEET	BACK SPLASH
2	WTRF48AHC	2/4	48	32	33.63	115	R: 1/6 F: 1/4	R: 2.0 F: 2.5	L: 5.31 R: 5.31	REMOVABLE
	WTFR48AHC									

For total height, add 3 or 6 inches, based on your mounting choice. Depth measurement includes handles and rear bumpers. "RF" in the model # designates refrigerator on the left, freezer on the right. "FR" in the model # designates freezer on the left, refrigerator on the right.



WTFR48AHC

# WORKTOPS

## Side-Mounted

### REFRIGERATORS - SIDE MOUNTED

MAINTAINS PRODUCT TEMPERATURES OF 36-38°F.

SECTIONS	MODEL #	DRAWERS	DOORS/ SHELVES	WIDTH	DEPTH	HEIGHT	VOLTS	HP	AMPS	CUBIC FEET	BACK SPLASH
1	WTR41AHC	-	1/2	41	34	33.5	115	1/6	2.2	7.94	FOAM
1	WTR46AHC	-	1/2	46	34	33.5	115	1/6	3	10.8	FOAM
	WTRD46AHC-2	2	-								
2	WTR67AHC	-	2/4	67	34	33.5	115	1/5	3	18.97	FOAM
	WTRD67AHC-2	2	1/2								
	WTRD67AHC-4	4	-								
3	WTR93AHC	-	3/6	93	34	33.5	115	1/3	5	29.7	FOAM
	WTRD93AHC-2	2	2/4								
	WTRD93AHC-4	4	1/2								
	WTRD93AHC-6	6	-								
4	WTR119AHC	-	4/8	119	34	33.5	115	1/3	5	40.12	FOAM
	WTRD119AHC-2	2	3/6								
	WTRD119AHC-4	4	2/4								
	WTRD119AHC-6	6	1/2								
	WTRD119AHC-8	8	-								

For total height, add 3 or 6 inches, based on your mounting choice. Depth measurement includes handles and rear bumpers.

### FREEZERS - SIDE MOUNTED

MAINTAINS PRODUCT TEMPERATURE AT 0° F AND BELOW.

SECTIONS	MODEL #	DRAWERS	DOORS/ SHELVES	WIDTH	DEPTH	HEIGHT	VOLTS	HP	AMPS	CUBIC FEET	BACK SPLASH
2	WTF67AHC	-	2/4	67	34	33.5	115	3/4	8.9	20.8	FOAM

For total height, add 3 or 6 inches, based on your mounting choice. Depth measurement includes handles and rear bumpers.

## REAR MOUNT VERSUS SIDE MOUNT

### REAR MOUNTED COMPRESSOR UNITS

Worktops and undercounter units that have a rear mounted compressor offer the advantage of a compressed footprint on the kitchen floorplan.



WTRD72AHC-4

### SIDE MOUNTED COMPRESSOR UNITS

Worktops and undercounter units that have a side mounted compressor are a little wider than rear mounted units, but gain a considerable amount of interior cubic capacity.



WTRD93AHC-4



# UNDERCOUNTERS

## Refrigerators & Freezers



**Designed to perform in  
high ambient conditions**

**3 year parts and labor warranty  
with an additional 4 year  
compressor part warranty**

**Made in USA**

**Undercounter units feature a 1/2" thick sub-top**

**Full electronic control**

**Interior thermometer**

**Self-closing doors**

with 120° stay-open feature, on cartridge style hinges

**Easy door removal for service and cleaning**

**Magnetic gasket attached to each door**

for positive seal

**6" heavy duty casters standard**

3" casters or 6" leg option available  
at no charge when specified on order

**Two epoxy-coated steel wire shelves**

per section

**Field-reversible doors**

On select models



**DRAWER PAN CONFIGURATIONS**  
for UCRD and UCFD units

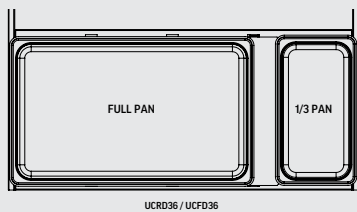

UCRD36 / UCFD36

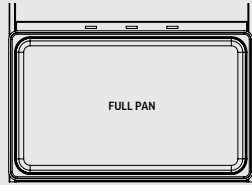

UCRD27 / UCRD32 / UCRD60  
UCFD27 / UCFD32 / UCFD60

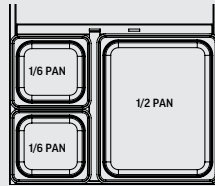

UCRD48 / UCRD72 / UCFD48

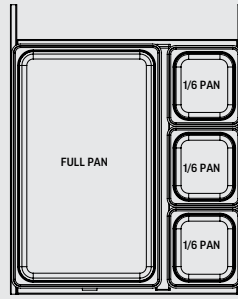

UCRD46 / UCRD67 / UCRD93 / UCRD119  
UCFD46 / UCFD67 / UCFD93 / UCFD119

**EXTERIOR FINISHES**

- Stainless steel with galvanized back
- Stainless steel with stainless back

**INTERIOR FINISHES**

- Corrosion-resistant aluminum
- Stainless steel

**AVAILABLE OPTIONS**

- Left hinge doors
- Remote models available
- Glass doors (rear-mount units only)

**AVAILABLE ACCESSORIES**

- Bun tray rack
- Locks (doors only, spec at time of order)

**MOUNTING OPTIONS**

- 6" casters
- 3" casters (allows for ADA compliant working height)
- 6" legs

**AGENCY CERTIFICATIONS**



**3" CASTERS AVAILABLE**  
at no charge when specified at the  
time of order



**FIELD-REVERSIBLE DOORS**  
for layout flexibility

AVAILABLE IN REAR MOUNTED AND SIDE MOUNTED SYSTEMS, WITH SOLID OR GLASS DOORS



# UNDERCOUNTERS

## Rear-Mounted Refrigeration

### REFRIGERATORS - REAR MOUNTED

MAINTAINS PRODUCT TEMPERATURES OF 36-38°F.

SECTIONS	MODEL #	DRAWERS	DOORS/ SHELVES	WIDTH	DEPTH	HEIGHT	VOLTS	HP	AMPS	CUBIC FEET
1	UCR24AHC	–	1/2	24	32	28.63	115	1/10	2	5.16
1	UCR27AHC	–	1/2	27	32	28.63	115	1/10	2	6.13
	UCRD27AHC-2	2	–							6.13
1	UCR32AHC	–	1/2	32	32	28.63	115	1/10	2	7.2
	UCRD32AHC-2	2	–							7.2
2	UCR36AHC	–	2/4	36	32	28.63	115	1/6	2	8.5
	UCRD36AHC-2	2	–							8.5
2	UCR48AHC	–	2/4	48	32	28.63	115	1/6	2	11.82
	UCRD48AHC-2	2	1/2							11.6
	UCRD48AHC-4	4	–							11.6
2	UCR60AHC	–	2/4	60	32	28.63	115	1/5	3	14.75
	UCRD60AHC-2	2	1/2							14.4
	UCRD60AHC-4	4	–							14.4
3	UCR72AHC	–	3/6	72	32	28.63	115	1/5	3	17.88
	UCRD72AHC-2	2	2/4							17.1
	UCRD72AHC-4	4	1/2							17.1
	UCRD72AHC-6	6	–							17.1

For total height, add 3 or 6 inches, based on your mounting choice. Depth measurement includes handles and rear bumpers.

## Shallow Depth Refrigeration (Rear-Mounted)

### REFRIGERATORS (SHALLOW DEPTH)

MAINTAINS PRODUCT TEMPERATURES OF 36-38°F.

SECTIONS	MODEL #	DOORS/ SHELVES	WIDTH	DEPTH	HEIGHT	VOLTS	HP	AMPS	CUBIC FEET
1	UCR20HC	1/2	20	24.5	25.13	115	1/10	2	2.25
1	UCR24HC	1/2	24	29.88	28.63	115	1/10	2	4.48
1	UCR27HC	1/2	27	29.88	28.63	115	1/10	2	5.25
2	UCR34HC	2/2	34	24.63	25.13	115	1/10	2	5.96

*For total height, add 3 or 6 inches, based on your mounting choice.  
Depth measurement includes handles and rear bumpers.*



# UNDERCOUNTERS

## Rear-Mounted Freezers

### FREEZERS - REAR MOUNTED

MAINTAINS PRODUCT TEMPERATURE AT 0° F AND BELOW.

SECTIONS	MODEL #	DRAWERS	DOORS/SHELVES	WIDTH	DEPTH	HEIGHT	VOLTS	HP	AMPS	CUBIC FEET
1	UCF24AHC	–	1/2	24	32	28.63	115	1/4	2.5	4.9
1	UCF27AHC	–	1/2	27	32	28.63	115	1/4	2.5	6.13
	UCFD27AHC-2	2	–							6.13
1	UCF32AHC	–	1/2	32	32	28.63	115	1/3+	4	7.2
	UCFD32AHC-2	2	–							7.2
2	UCF36AHC	–	2/4	36	32	28.63	115	1/2	6	8.7
	UCFD36AHC-2	2	–							8.7
2	UCF48AHC	–	2/4	48	32	28.63	115	1/2	7	11.04
	UCFD48AHC-2	2	1/2							11.6
	UCFD48AHC-4	4	–							11.6
2	UCF60AHC	–	2/4	60	32	28.63	115	1/2	7	14.39
	UCFD60AHC-2	2	1/2							15.8
	UCFD60AHC-4	4	–							15.8

For total height, add 3 or 6 inches, based on your mounting choice. Depth measurement includes handles and rear bumpers.

## Shallow Depth Freezers (Rear-Mounted)

### FREEZERS (SHALLOW DEPTH)

MAINTAINS PRODUCT TEMPERATURE AT 0° F AND BELOW.

SECTIONS	MODEL #	DOORS/SHELVES	WIDTH	DEPTH	HEIGHT	VOLTS	HP	AMPS	CUBIC FEET
1	UCF20HC	1/2	20	24.5	25.13	115	1/4	2.5	2.34
1	UCF24HC	1/2	24	29.88	28.63	115	1/4	2.5	4.53
1	UCF27HC	1/2	27	29.88	28.63	115	1/4	2.5	5.25

For total height, add 3 or 6 inches, based on your mounting choice. Depth measurement includes handles and rear bumpers.

## Rear-Mounted Dual-Temps

### DUAL-TEMPS

MAINTAINS PRODUCT TEMPERATURES OF 36-38°F (REFRIGERATOR), AND 0°F (FREEZER).

SECTIONS	MODEL #	DOORS/SHELVES	WIDTH	DEPTH	HEIGHT	VOLTS	HP	AMPS	CUBIC FEET
2	UCRF48AHC	2/4	48	32	28.63	115	R: 1/6	R: 2.0	L: 5.31
	UCFR48AHC						F: 1/4	F: 2.5	R: 5.31

*For total height, add 3 or 6 inches, based on your mounting choice.  
 Depth measurement includes handles and rear bumpers.  
 "RF" in the model # designates refrigerator on the left, freezer on the right.  
 "FR" in the model # designates freezer on the left, refrigerator on the right.*



UCRF48AHC



# UNDERCOUNTERS

## Side-Mounted

### REFRIGERATORS - SIDE MOUNTED

MAINTAINS PRODUCT TEMPERATURES OF 36-38°F.

SECTIONS	MODEL #	DRAWERS	DOORS/ SHELVES	WIDTH	DEPTH	HEIGHT	VOLTS	HP	AMPS	CUBIC FEET
1	UCR41AHC	-	1/2	41	34.75	28.5	115	1/5	2	7.94
1	UCR46AHC	-	1/2	46	34.75	28.5	115	1/5	2	10.8
	UCRD46AHC-2	2	-							10.8
2	UCR67AHC	-	2/4	67	34.75	28.5	115	1/5	2	18.97
	UCRD67AHC-2	2	1/2							19.2
	UCRD67AHC-4	4	-							19.2
3	UCR93AHC	-	3/6	93	34.75	28.5	115	1/3	5	29.7
	UCRD93AHC-2	2	2/4							29.7
	UCRD93AHC-4	4	1/2							29.7
	UCRD93AHC-6	6	-							29.7
4	UCR119AHC	-	4/8	119	34.75	28.5	115	1/3	5	40.12
	UCRD119AHC-2	2	3/6							40.5
	UCRD119AHC-4	4	2/4							40.5
	UCRD119AHC-6	6	1/2							40.5
	UCRD119AHC-8	8	-							40.5

For total height, add 3 or 6 inches, based on your mounting choice. Depth measurement includes handles and rear bumpers.

### FREEZERS - SIDE MOUNTED

MAINTAINS PRODUCT TEMPERATURE AT 0° F AND BELOW.

SECTIONS	MODEL #	DOORS/ SHELVES	WIDTH	DEPTH	HEIGHT	VOLTS	HP	AMPS	CUBIC FEET
2	UCF67AHC	2/4	67	34.75	28.5	115	3/4	6.4	20.8

For total height, add 3 or 6 inches, based on your mounting choice.  
Depth measurement includes handles and rear bumpers.



UCR27AHC-25-09-23

# Worktop & Undercounter Accessories

DESCRIPTION	UNIT(S)	PART NUMBER
<b>SHELVING / ORGANIZERS</b>		
Epoxy Coated Wire Shelf (Large)	UCF/UCR/WTF/WTR27A	403-826B
Epoxy Coated Wire Shelf (Small)	UCF/UCR/WTF/WTR27A	403-912D-01
Epoxy Coated Wire Shelf (Large)	UCF/UCR/WTF/WTR36A	403-911D-01
Epoxy Coated Wire Shelf (Small)	UCF/UCR/WTF/WTR36A	403-915D-01
Epoxy Coated Wire Shelf (Large)	UCF/UCR/WTF/WTR48A	403-828B
Epoxy Coated Wire Shelf (Small)	UCF/UCR/WTF/WTR48A	403-913D-01
Epoxy Coated Wire Shelf (Large)	UCF/UCR/WTF/WTR60A	403-829B
Epoxy Coated Wire Shelf (Small)	UCF/UCR/WTF/WTR60A	403-914D-01
Epoxy Coated Ctr Section Wire Shelf (Large)	UCR/WTR72A	403-827B
Epoxy Coated Wire Shelf L&R (Large)	UCR/WTR72A	403-828B
Epoxy Coated Ctr Section Wire Shelf (Small)	UCR/WTR72A	403-912D-01
Epoxy Coated Wire Shelf L&R (Small)	UCR/WTR72A	403-913D-01
Epoxy Coated Wire Shelf	UCR46A/67A, UCF67A	403-834D
Epoxy Coated Wire Shelf	UCR93A/119A	403-834D
Epoxy Coated Wire Shelf	WTR41/46/67A/93A	403-834D
Epoxy Coated Wire Shelf	WTR119A, WTF67A	403-834D
Epoxy Coated Wire Shelf	UCF/UCR/WTR20	403-419D
Epoxy Coated Wire Shelf	UCR/WTR34Y	403-339D
Epoxy Coated Wire Shelf	UCR/UCF/WTF/WTR27 Shallow Depth	403-294D
Shelf Clip	UCR/WTR/UCRD/WTRD	403-169A
Large Wire Shelf Divider	WTR27A/UCR27A	403-722C
Small Wire Shelf Divider	WTR27A/UCR27A	403-721C
Large Wire Shelf Divider	WTR36A, UCR36A	403-723C
Small Wire Shelf Divider	WTR36A, UCR36A	403-721C
Large Wire Shelf Divider	WTR48A/UCR48A	403-723C
Small Wire Shelf Divider	WTR48A/UCR48A	403-721C
Large Wire Shelf Divider	WTR60A/UCR60A	403-723C
Small Wire Shelf Divider	WTR60A/UCR60A	403-721C
Large Wire Shelf Divider	WTR72A/UCR72A	403-723C
Small Wire Shelf Divider	WTR72A/UCR72A	403-721C
<b>STACKING COLLARS</b>		
Stacking Collar	UCR20HC, UCF20HC	00C32-015A-01
Wall Mount Shelf	UCR20HC, UCF20HC (3/16" anchors recommended for mounting)	00A24-136D-05
Stacking Collar	UCR27HC, UCF27HC	00C32-004A
Stacking Collar	UCR27AHC, UCF27AHC	00C32-012A

DESCRIPTION	UNIT(S)	PART NUMBER
<b>MOUNTING</b>		
3" Caster	UCR20,UCF20,UCR27,UCF27,UCR34	00C31-041A
6" Caster	UCR20,UCF20,UCR27,UCF27,UCR34	00C31-038A
3" Caster	29" Undercounter/Worktop (set of four)	00C31-041A
6" Caster	29" Undercounter/Worktop (set of four)	00C31-038A
3" Caster	32" Undercounter/Worktop (set of four)	61C01-013A
6" Caster	32" Undercounter/Worktop (set of four)	61C01-001A
3" Caster	UCR/WTR 119A (set of six)	61C01-012A
6" Black Leg	29" Undercounter/Worktop ( set of four)	58B02-001A
6" Black Leg	32" Undercounter/Worktop ( set of four)	58B02-001A
6" Black Leg	UCR/WTR 119A (set of six)	58B02S002A
6" Seismic/Flanged Legs	29" WT/UC (set of four)	00C31-055A
6" Seismic/Flanged Legs	32" WT/UC (set of four)	00C31-055A
6" Seismic/Flanged Legs	UC Shallow Depth (set of four)	00C31-055A
2 3/4 in Caster Kit	WT/UC	00C31-049A
2" Roller Kit	WT/UC	00C31-045A

<b>WORKTOP WHITE POLY CUTTING BOARDS (1/2" THICK)</b>		
Set of (2) Brackets Required	All Units	00C23-076A-01
29" Cutting Board	WTR27A/WTF27A	705-397D-05
29" Cutting Board	WTR36A/WTF36A	705-397D-19
29" Cutting Board	WTR48A/WTF48A	705-397D-06
29" Cutting Board	WTR60A/WTF60A	705-397D-07
29" Cutting Board	WTR72A/WTF72A	705-397D-08

<b>COMPOSITE CUTTING BOARDS (1/2" THICK)</b>		
Set of (2) Brackets Required	All Units	00C23-076A-01
Composite Cutting Board	WTR27A/WTF27A	705-397D-03
Composite Cutting Board	WTR36A/WTF36A	705-397D-17
Composite Cutting Board	WTR41	705-397D-18
Composite Cutting Board	WTR48A/WTF48A	705-397D-02
Composite Cutting Board	WTR60A/WTF60A	705-397D-04
Composite Cutting Board	WTR72A	705-397D-01

<b>ADDITIONAL ACCESSORIES</b>		
Door Lock (solid doors only)	UCR,WTR (per door; solid doors only)	00C30-099A





# CHEF BASES

AMPLE COLD STORAGE WHILE SUPPORTING WORK SPACES





# CHEF BASES

## Refrigerators & Freezers



**Designed to perform in high ambient conditions**

**3 year parts and labor warranty with an additional 4 year compressor part warranty**

**LIFETIME WARRANTY on all drawers and slides** (parts only)

**12-gauge stainless steel drawer slides with Delrin® rollers rated at 275 lbs**

**Heavy-duty, fireproof, reinforced, insulated 16-gauge top with fully integrated heat-shield**  
(must adhere to manufacturer's clearance)

**Compressor available on left or right side**  
(specify at time of order)

**Consistent product temperature with intelligent airflow design**

**Improved drawer systems for easier installation, field adjustment, and increased pan capacity**

**Full refrigeration system serviceability from the front of the cabinet, eliminating the need to remove the lid**

**Accommodates 6-inch-deep full-size food service pans in top & bottom drawers**

**Featuring environmentally friendly energy-efficient R290 refrigerant**





**Optional overhang top**  
(up to 6-inches on either side)

**EXTERIOR FINISHES**

- Stainless steel with galvanized back

**INTERIOR FINISHES**

- Corrosion-resistant aluminum
- Stainless steel

**AVAILABLE OPTIONS**

- Flat Top edge in lieu of marine edge on standard sizes
- Remote models available

**AVAILABLE ACCESSORIES**

- Custom flat top sizes available, up to 6" overhang on either side to create a custom sized top
- Gasket guards

**MOUNTING OPTIONS**

- 6" casters
- 3" casters (allows for ADA compliant working height)
- 6" legs

**AGENCY CERTIFICATIONS**



**12-GAUGE DRAWER SLIDES**  
with 3 Delrin encased stainless steel roller bearings per each drawer slide



**ACCOMMODATES 6" PANS IN**  
top and bottom drawers



# CHEF BASES

## REFRIGERATORS

MAINTAINS PRODUCT TEMPERATURES OF 36-38°F.

SECTIONS	MODEL #	DRAWERS	TOP WIDTH	CABINET WIDTH	DEPTH	HEIGHT	VOLTS	HP	AMPS	CUBIC FEET	FULL SIZE PAN CAPACITY
1	WTRCS36HC	2 small	36	36	34.75	24.38	115	1/6	1.7	5.64	4
	WTRCS36HC-48		48								
1	WTRCS48HC	2 medium	48	48	34.75	24.38	115	1/6	1.7	8.59	4
1	WTRCS52HC	2 large	52	52	34.75	24.38	115	1/6	1.7	9.58	6
	WTRCS52HC-60		60								
1	WTRCS60HC	2 X-large	60	60	34.75	24.38	115	1/6	1.7	11.55	6
	WTRCS60HC-64		64								
2	WTRCS72HC	4 medium	72	72	34.75	24.38	115	1/3	5	14.51	8
	WTRCS72HC-76		76								
2	WTRCS84HC	2 medium 2 X-large	84	84	34.75	24.38	115	1/3	5	17.46	10
	WTRCS84HC-89		89								
	WTRCS84HC-96		96								
2	WTRCS96HC	4 X-large	96	96	34.75	24.38	115	1/3	5	20.42	12
	WTRCS96HC-108		108								
3	WTRCS112HC	4 medium 2 large	112	112	34.75	24.38	115	1/3	5	24.36	14
	WTRCS112HC-120		120								

Height measurement includes casters. Depth measurement includes handles and rear bumpers.

### DRAWER PAN CONFIGURATIONS for Chef Base units

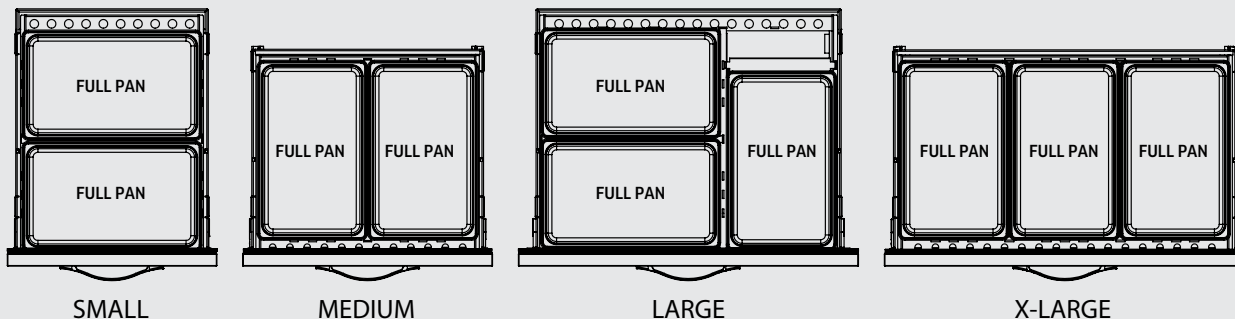

**FREEZERS**

MAINTAINS PRODUCT TEMPERATURE AT -10° F AND BELOW.

SECTIONS	MODEL #	DRAWERS	TOP WIDTH	CABINET WIDTH	DEPTH	HEIGHT	VOLTS	HP	AMPS	CUBIC FEET	FULL SIZE PAN CAPACITY
1	WTFC36HC	2 small	36	36	34.75	24.38	115	1/2	4.5	5.64	4
	WTFC36HC-48		48								
1	WTFC48HC	2 medium	48	48	34.75	24.38	115	1/2	4.5	8.59	4
1	WTFC52HC	2 large	52	52	34.75	24.38	115	1/2	4.5	9.58	6
	WTFC52HC-60		60								
1	WTFC60HC	2 X-large	60	60	34.75	24.38	115	3/4	6.5	11.55	6
	WTFC60HC-64		64								
2	WTFC72HC	4 medium	72	72	34.75	24.38	115	3/4	6.5	14.51	8
	WTFC72HC-76		76								
2	WTFC84HC	2 medium 2 X-large	84	84	34.75	24.38	115	3/4	6.5	17.46	10
	WTFC84HC-89		89								
	WTFC84HC-96		96								
2	WTFC96HC	4 X-large	96	96	34.75	24.38	115	3/4	6.5	20.42	12
	WTFC96HC-108		108								

*Height measurement includes casters. Depth measurement includes handles and rear bumpers.*







# BAR & WINE EQUIPMENT

DYNAMIC PERFORMANCE THAT ENHANCES THE FRONT OF THE HOUSE



**Direct Draws / Bar Mobiles**



**Back Bar Coolers**



**Bottle Coolers**



**Glass & Plate Chillers**



# DIRECT DRAWS



## 3-IN-1 DRAFT SOLUTIONS

Dispense beer, wine, or coffee (other non-alcoholic beverages) with the same tap—no line/manifold changes needed!

**Wide variety of options and accessories**

**3 year parts and labor warranty  
with an additional 4 year  
compressor part warranty**

**Made in USA**

**Stainless steel top with drip tray**

**Galvanized steel interior liner**  
with heavy duty stainless steel floor

**Full electronic control**

**Drain tube located at bottom front of cooler**  
connects to floor drain

**Self-closing doors with locks**

**Magnetic gasket attached to each door**  
for positive seal

**Field-reversible door**

**Compressor available on left or right side**  
specify at time of order



## LEFT OR RIGHT COMPRESSOR

Specify which side the compressor should be located at time of order



## DRAIN TUBE

bottom front of cooler (condensor side) and connects directly to floor drain

REFRIGERATED UNITS

MAINTAINS PRODUCT TEMPERATURES OF 36-38°F.

SECTIONS	MODEL #	DOORS	# OF STRAIGHT WALL KEGS	WIDTH	DEPTH	HEIGHT	VOLTS	HP	AMPS	CUBIC FEET	COLOR
1	DD24HC-1-B	1	1	24	30.13	37.75	115	1/6	2	7.66	BLACK
	DD24HC-1-S										STAINLESS FRONT
1	DD36HC-1-B	1	1	36	24.5	36	115	1/4	2.5	8.31	BLACK
	DD36HC-1-S										STAINLESS
2	DD48HC-1-B	2	2	48	24.5	36	115	1/4	2.50	12.4	BLACK
	DD48HC-1-S										STAINLESS
2	DD50HC-1-B	2	2	50.5	29	37.38	115	1/4	2.50	17.86	BLACK
	DD50HC-1-S										STAINLESS FRONT
2	DD58HC-1-B	2	3	59	29	37.38	115	1/4	2.50	21.86	BLACK
	DD58HC-1-S										STAINLESS FRONT
2	DD68HC-1-B	2	3	69	29	37.38	115	1/3	5.5	25.93	BLACK
	DD68HC-1-S										STAINLESS FRONT
3	DD72HC-1-B	3	3	72	24.5	36	115	1/3	3.1	19.95	BLACK
	DD72HC-1-S										STAINLESS
3	DD78HC-1-B	3	4	79	29	37.38	115	1/3	5.5	33.59	BLACK
	DD78HC-1-S										STAINLESS FRONT
3	DD94HC-1-B	3	5	95	29	37.38	115	1/3	5.5	37.82	BLACK
	DD94HC-1-S										STAINLESS FRONT

Depth measurement includes handles. Height measurement includes mounting height (DD24 only), but excludes tap height. Add average tap height of 15" for total unit height.

12-Tap Tower Option

Available for DD78 and DD94.

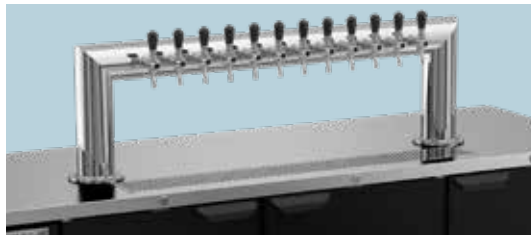

Club Top Option

Adds sliding lid(s) to top. Available for DD50, DD58 and DD68.



EXTERIOR FINISHES

- Black
- Stainless Steel

INTERIOR FINISHES

- Galvanized walls with reinforced stainless steel floor
- Stainless steel

AVAILABLE OPTIONS

- Left or right side compressor
- Remote models available

AVAILABLE ACCESSORIES

- Wine Models
- Wine Taps
- Faucet Locks
- Glass Rinser
- 1-6 Insulated Stainless Towers/Taps
- Optional 12 Tap Tower for DD78 & 94
- Dual Tap Placement Option
- No Draft Arm with Hole Cover
- Club Top available on DD50, 58, & 68

MOUNTING OPTIONS

- 6" casters
- 3" casters
- 6" legs

AGENCY CERTIFICATIONS



# DIRECT DRAWS

## Keg Capacities

DD24 / DD36

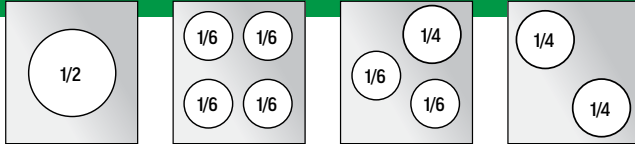

DD48 / DD50

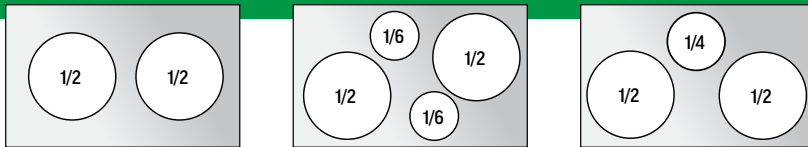

DD58 / DD68 / DD72

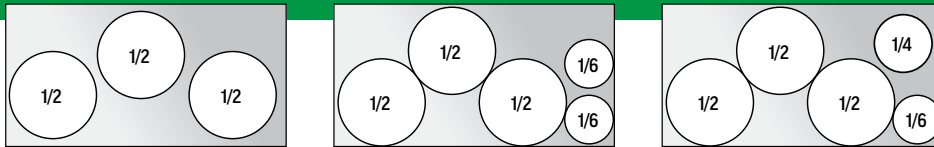

DD78

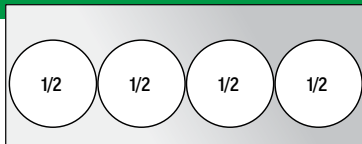

DD94

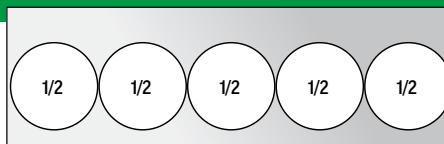

# RC-500 SERIES RAPID CHILL GLASS FROSTER

**Freeze any type of glass in a flash**

**Ideal for chilling beer, champagne, wine, and cocktail glasses**

**Also ideal for chilling the exterior of bottles**

**Simply push down on the froster head to dispense jet of CO2**

**Neon, color changing lights illuminate the glass as you frost**

**Does not taint the taste of drinks**

**RC-500 mounts to any table or bar counter**

**Sterilizes the glass due to the cooling process, for a more hygienic drink service**

**Will not affect the carbonation or temperature of drinks**

**No need for electrical connection, for greater portability and practicality**

**LED lights require (2) AA batteries**

**Requires food grade CO2 cylinders with liquid dip tube (siphon tank)**

MODEL #	WIDTH	DEPTH	HEIGHT	CRATED WEIGHT
RC-500	10.63	5.11	16.14	12



# BAR MOBILES



**Wide variety of options and accessories**

**3 year parts and labor warranty  
with an additional 4 year  
compressor part warranty**

**Made in USA**

**Stainless steel drip tray for easy cleaning**

**Heavy-duty stainless steel floor**

**Stainless steel top with black glass rails**

**4" casters**

**Full electronic control**

**Interior thermometer**

**Tower has continuous source of cold air**

**Portable unit with waste bottle**

for beer and wine from drain

**Self-closing doors with locks**

**Field-reversible door**

**Magnetic gasket attached to each door**

for positive seal



**PORTABLE WASTE BOTTLE**

for beer and wine from drain



**STAINLESS STEEL DRIP TRAY**

for easy cleaning

**REFRIGERATED UNITS**

MAINTAINS PRODUCT TEMPERATURES OF 36-38°F.

SECTIONS	MODEL #	DOORS	# OF STRAIGHT WALL KEGS	WIDTH	DEPTH	HEIGHT	VOLTS	HP	AMPS	CUBIC FEET	COLOR
1	BM23HC-B	1	1	24	30.13	53	115	1/6	2	7.66	BLACK
	BM23HC-B-28	1	1	24	30.13	39.37	115	1/6	2	7.66	BLACK
	BM23HC-S-31	1	1	24	30.13	53	115	1/6	2	7.66	STAINLESS
	BM23HC-C-B	1	1	24	30.13	53.25	115	1/6	2	7.66	BLACK
	BM23HC-C-S	1	1	24	30.13	53.25	115	1/6	2	7.66	STAINLESS

Depth measurement includes handles. Height measurement includes mounting height and tap height if applicable.

**DUAL ZONE** *Not intended for beer/beer configuration.*

LEFT COMPARTMENT MAINTAINS 32-40°F.  
RIGHT COMPARTMENT MAINTAINS 50-65°F.

SECTIONS	MODEL #	DOORS	# OF STRAIGHT WALL KEGS	WIDTH	DEPTH	HEIGHT	VOLTS	HP	AMPS	CUBIC FEET	COLOR
1	DZ24-1-B	1	(4) 1/6	24	30.13	53	115	1/5	4	7.12	BLACK
	DZ24-1-S										STAINLESS

Depth measurement includes handles. Height measurement includes mounting height and tap height if applicable.

**EXTERIOR FINISHES**

- Black
- Stainless Steel

**INTERIOR FINISHES**

- Galvanized walls with reinforced stainless steel floor
- Stainless steel

**AVAILABLE OPTIONS**

- Outdoor approved unit available (BM23 only)

**AVAILABLE ACCESSORIES**

- Club top (BM23 only)
- 1-4 insulated stainless towers/taps
- Wine models available
- 2, 3, or 4-way manifolds
- Faucet locks
- No draft arm with hole cover

**MOUNTING OPTIONS**

- 4" casters

**AGENCY CERTIFICATIONS**





# BACK BAR COOLERS



**Wide variety of options and accessories**

**3 year parts and labor warranty  
with an additional 4 year  
compressor part warranty**

**Made in USA**

## **Galvanized Steel Interior**

## **Stainless Steel Floor**

## **Full electronic control**

## **Compressor Available on Left or Right Side**

specify at time of order  
right side only on pass-thru models

## **LED Lighting**

## **Two Epoxy Coated Shelves per section**

## **Stay Open Door and Locks**

## **Field-reversible Doors**

on select models

## **Sliding Glass Doors**

on select models (door frames only come in black)

## **Pass Thru Models Available**

## **Magnetic gasket attached to each door**

for positive seal



**DOOR OPTIONS**

- Solid doors (hinged)
- Glass doors (hinged)
- Glass doors (sliding)

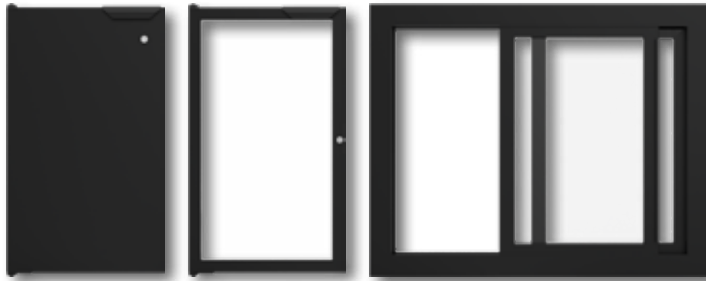

**EXTERIOR FINISHES**

- Black
- Stainless Steel front/sides
- Stainless steel front with gray painted steel sides

**INTERIOR FINISHES**

- Galvanized steel with reinforced stainless steel floor
- Stainless steel

**AVAILABLE OPTIONS**

- Left or right side compressor (right side only on pass-thru's)
- Remote models available

**AVAILABLE ACCESSORIES**

- Wine models available
- Food rated models
- Glass door
- Stainless steel top and galvanized sub-tops available
- Extra shelves

**MOUNTING OPTIONS**

- 6" casters
- 3" casters
- 6" legs

**AGENCY CERTIFICATIONS**



**LEFT OR RIGHT COMPRESSOR**

Specify which side the compressor should be located at time of order; right side only on pass-thru's



**OPEN FOOD RATED MODELS**

for increased storage options

AVAILABLE IN REACH-IN OR PASS-THRU, WITH OR WITHOUT TOP, WITH OR WITHOUT OPEN FOOD RATED



# BACK BAR COOLERS

## Standard

### SOLID DOORS

MAINTAINS PRODUCT TEMPERATURES OF 36-38°F.

SECTIONS	MODEL #	DOORS/ SHELVES	# OF STRAIGHT WALL KEGS	12oz CANS	12oz BOTTLES	LONGNECK BOTTLES	WIDTH	DEPTH	HEIGHT	VOLTS	HP	AMPS	CUBIC FEET	COLOR
1	BB24HC-1-B	1/2	1	180	140	110	24	30.13	37.75	115	1/6	2	7.66	BLACK
	BB24HC-1-S													STAINLESS FRONT
1	BB36HC-1-B	1/2	1	240	220	170	36	24.5	34	115	1/4	2.5	8.31	BLACK
	BB36HC-1-S													STAINLESS
1	BB36HC-1-B-27	1/2	1	240	220	170	36	24.5	36	115	1/4	2.5	8.31	BLACK
	BB36HC-1-S-27													STAINLESS
2	BB48HC-1-B	2/4	2	288	300	325	48	24.5	34	115	1/4	2.5	12.4	BLACK
	BB48HC-1-S													STAINLESS
2	BB48HC-1-B-27	2/4	2	288	300	325	48	24.5	36	115	1/4	2.5	12.4	BLACK
	BB48HC-1-S-27													STAINLESS
2	BB58HC-1-B	2/4	2	528	440	365	59	29.13	37.25	115	1/4	2.5	21.86	BLACK
	BB58HC-1-S													STAINLESS FRONT
2	BB68HC-1-B	2/4	3	672	550	435	69	29.13	37.25	115	1/3	5.3	25.93	BLACK
	BB68HC-1-S													STAINLESS FRONT
3	BB72HC-1-B	3/6	3	540	480	505	72	24.5	34	115	1/3	3.1	19.92	BLACK
	BB72HC-1-S													STAINLESS
3	BB72HC-1-B-27	3/6	3	540	480	505	72	24.5	36	115	1/3	3.1	19.92	BLACK
	BB72HC-1-S-27													STAINLESS
3	BB78HC-1-B	3/6	4	740	630	560	79	29.13	37.25	115	1/3	5.5	33.59	BLACK
	BB78HC-1-S													STAINLESS FRONT
3	BB94HC-1-B	3/6	5	920	785	675	95	29.13	37.25	115	1/3	5.5	37.82	BLACK
	BB94HC-1-S													STAINLESS FRONT

Depth measurement includes handles. BB24 height measurement includes mounting height.

### AVAILABLE TOPS



1.5-INCH STAINLESS STEEL TOP  
indicated with green model #  
example: BB58HC-1-B



2-INCH STAINLESS STEEL TOP  
indicated with black model # and "-27"  
example: BB48HC-1-B-27



GALVANIZED SUB-TOP  
indicated with black model #  
example: BB48HC-1-B

**GLASS DOORS (HINGED)**

MAINTAINS PRODUCT TEMPERATURES OF 36-38°F.

SECTIONS	MODEL #	DOORS/SHELVES	# OF STRAIGHT WALL KEGS	12oz CANS	12oz BOTTLES	LONGNECK BOTTLES	WIDTH	DEPTH	HEIGHT	VOLTS	HP	AMPS	CUBIC FEET	COLOR
1	BB24HC-1-G-B	1/2	1	180	140	110	24	30.13	37.75	115	1/6	2	7.66	BLACK
	BB24HC-1-G-S													STAINLESS FRONT
1	BB36HC-1-G-B	1/2	1	240	220	170	36	24.5	34	115	1/4	2.5	8.36	BLACK
	BB36HC-1-G-S													STAINLESS
1	BB36HC-1-G-B-27	1/2	1	240	220	170	36	24.5	36	115	1/4	2.5	8.36	BLACK
	BB36HC-1-G-S-27													STAINLESS
2	BB48HC-1-G-B	2/4	2	288	300	325	48	24.5	34	115	1/4	2.5	12.4	BLACK
	BB48HC-1-G-S													STAINLESS
2	BB48HC-1-G-B-27	2/4	2	288	300	325	48	24.5	36	115	1/4	2.5	12.4	BLACK
	BB48HC-1-G-S-27													STAINLESS
2	BB58HC-1-G-B	2/4	2	528	440	365	59	29.13	37.25	115	1/4	2.5	21.86	BLACK
	BB58HC-1-G-S													STAINLESS FRONT
2	BB68HC-1-G-B	2/4	3	672	550	435	69	29.13	37.25	115	1/3	5.3	25.93	BLACK
	BB68HC-1-G-S													STAINLESS FRONT
3	BB72HC-1-G-B	3/6	3	540	480	505	72	24.5	34	115	1/3	3.1	19.92	BLACK
	BB72HC-1-G-S													STAINLESS
3	BB72HC-1-G-B-27	3/6	3	540	480	505	72	24.5	36	115	1/3	3.1	19.92	BLACK
	BB72HC-1-G-S-27													STAINLESS
3	BB78HC-1-G-B	3/6	4	740	630	560	79	29.13	37.25	115	1/3	5.5	33.59	BLACK
	BB78HC-1-G-S													STAINLESS FRONT
3	BB94HC-1-G-B	3/6	5	920	785	675	95	29.13	37.25	115	1/3	5.5	37.82	BLACK
	BB94HC-1-G-S													STAINLESS FRONT

Depth measurement includes handles. BB24 height measurement includes mounting height.

**GLASS DOORS (SLIDING)** (Door frame only comes in black)

MAINTAINS PRODUCT TEMPERATURES OF 36-38°F.

SECTIONS	MODEL #	DOORS/SHELVES	# OF STRAIGHT WALL KEGS	12oz CANS	12oz BOTTLES	LONGNECK BOTTLES	WIDTH	DEPTH	HEIGHT	VOLTS	HP	AMPS	CUBIC FEET	COLOR
2	BB48HC-1-GS-B	2/4	2	288	300	325	48	23.63	34	115	1/4	2.5	12.4	BLACK
	BB48HC-1-GS-S													STAINLESS
2	BB48HC-1-GS-B-27	2/4	2	288	300	325	48	23.63	36	115	1/4	2.5	12.4	BLACK
	BB48HC-1-GS-S-27													STAINLESS
2	BB58HC-1-GS-B	2/4	2	528	440	365	59	28.25	37.25	115	1/4	2.5	21.86	BLACK
	BB58HC-1-GS-S													STAINLESS FRONT
3	BB72HC-1-GS-B	3/6	3	540	480	505	72	23.63	34	115	1/3	3.1	19.92	BLACK
	BB72HC-1-GS-S													STAINLESS
3	BB72HC-1-GS-B-27	3/6	3	540	480	505	72	23.63	36	115	1/3	3.1	19.92	BLACK
	BB72HC-1-GS-S-27													STAINLESS

Depth measurement includes handles.

# BACK BAR COOLERS

## Standard Pass-thru

### SOLID DOORS

MAINTAINS PRODUCT TEMPERATURES OF 36-38°F.

SECTIONS	MODEL #	DOORS/ SHELVES	# OF STRAIGHT WALL KEGS	12oz CANS	12oz BOTTLES	LONGNECK BOTTLES	WIDTH	DEPTH	HEIGHT	VOLTS	HP	AMPS	CUBIC FEET	COLOR
2	BB48HC-1-PT-B	4/4	2	288	300	325	48	27.38	34	115	1/3	3.1	13.6	BLACK
	BB48HC-1-PT-S													STAINLESS
2	BB48HC-1-PT-B-27	4/4	2	288	300	325	48	27.38	36	115	1/3	3.1	13.6	BLACK
	BB48HC-1-PT-S-27													STAINLESS
3	BB72HC-1-PT-B	6/6	3	540	480	505	72	27.38	34	115	1/3	3.1	22.1	BLACK
	BB72HC-1-PT-S													STAINLESS
3	BB72HC-1-PT-B-27	6/6	3	540	480	505	72	27.38	36	115	1/3	3.1	22.1	BLACK
	BB72HC-1-PT-S-27													STAINLESS

*Depth measurement includes handles.*



**GLASS DOORS (HINGED)**

MAINTAINS PRODUCT TEMPERATURES OF 36-38°F.

SECTIONS	MODEL #	DOORS/ SHELVES	# OF STRAIGHT WALL KEGS	12oz CANS	12oz BOTTLES	LONGNECK BOTTLES	WIDTH	DEPTH	HEIGHT	VOLTS	HP	AMPS	CUBIC FEET	COLOR
2	BB48HC-1-G-PT-B	4/4	2	288	300	325	48	27.38	34	115	1/3	3.1	13.6	BLACK
	BB48HC-1-G-PT-S													STAINLESS
2	BB48HC-1-G-PT-B-27	4/4	2	288	300	325	48	27.38	36	115	1/3	3.1	13.6	BLACK
	BB48HC-1-G-PT-S-27													STAINLESS
3	BB72HC-1-G-PT-B	6/6	3	540	480	505	72	27.38	34	115	1/3	3.1	22.1	BLACK
	BB72HC-1-G-PT-S													STAINLESS
3	BB72HC-1-G-PT-B-27	6/6	3	540	480	505	72	27.38	36	115	1/3	3.1	22.1	BLACK
	BB72HC-1-G-PT-S-27													STAINLESS

Depth measurement includes handles.

**GLASS DOORS (SLIDING)** *(Door frame only comes in black)*

MAINTAINS PRODUCT TEMPERATURES OF 36-38°F.

SECTIONS	MODEL #	DOORS/ SHELVES	# OF STRAIGHT WALL KEGS	12oz CANS	12oz BOTTLES	LONGNECK BOTTLES	WIDTH	DEPTH	HEIGHT	VOLTS	HP	AMPS	CUBIC FEET	COLOR
2	BB48HC-1-GS-PT-B	4/4	2	288	300	325	48	25.75	34	115	1/3	3.1	13.6	BLACK
	BB48HC-1-GS-PT-S													STAINLESS
2	BB48HC-1-GS-PT-B-27	4/4	2	288	300	325	48	25.75	36	115	1/3	3.1	13.6	BLACK
	BB48HC-1-GS-PT-S-27													STAINLESS
3	BB72HC-1-GS-PT-B	6/6	3	540	480	505	72	25.75	34	115	1/3	3.1	22.1	BLACK
	BB72HC-1-GS-PT-S													STAINLESS
3	BB72HC-1-GS-PT-B-27	6/6	3	540	480	505	72	25.75	36	115	1/3	3.1	22.1	BLACK
	BB72HC-1-GS-PT-S-27													STAINLESS

Depth measurement includes handles.

**AVAILABLE TOPS**



**2-INCH STAINLESS STEEL TOP**  
indicated with black model # and "-27"  
example: **BB48HC-1-G-PT-B-27**



**GALVANIZED SUB-TOP**  
indicated with black model #  
example: **BB48HC-1-G-PT-B**



# BACK BAR COOLERS

## Food Rated

### SOLID DOORS

MAINTAINS PRODUCT TEMPERATURES OF 36-38°F.

SECTIONS	MODEL #	DOORS/ SHELVES	# OF STRAIGHT WALL KEGS	12oz CANS	12oz BOTTLES	LONGNECK BOTTLES	WIDTH	DEPTH	HEIGHT	VOLTS	HP	AMPS	CUBIC FEET	COLOR
1	BB24HC-1-F-B	1/2	1	180	140	110	24	30.13	37.75	115	1/6	2	7.66	BLACK
	BB24HC-1-F-S													STAINLESS FRONT
1	BB36HC-1-F-B	1/2	1	240	220	170	36	24.5	34	115	1/4	2.5	8.31	BLACK
	BB36HC-1-F-S													STAINLESS
1	BB36HC-1-F-B-27	1/2	1	240	220	170	36	24.5	36	115	1/4	2.5	8.31	BLACK
	BB36HC-1-F-S-27													STAINLESS
2	BB48HC-1-F-B	2/4	2	288	300	325	48	24.5	34	115	1/4	2.5	12.4	BLACK
	BB48HC-1-F-S													STAINLESS
2	BB48HC-1-F-B-27	2/4	2	288	300	325	48	24.5	36	115	1/4	2.5	12.4	BLACK
	BB48HC-1-F-S-27													STAINLESS
2	BB58HC-1-F-B	2/4	2	528	440	365	59	29.13	37.25	115	1/4	2.5	21.86	BLACK
	BB58HC-1-F-S													STAINLESS FRONT
2	BB68HC-1-F-B	2/4	3	672	550	435	69	29.13	37.25	115	1/3	5.3	25.93	BLACK
	BB68HC-1-F-S													STAINLESS FRONT
3	BB72HC-1-F-B	3/6	3	540	480	505	72	24.5	34	115	1/3	3.1	19.92	BLACK
	BB72HC-1-F-S													STAINLESS
3	BB72HC-1-F-B-27	3/6	3	540	480	505	72	24.5	36	115	1/3	3.1	19.92	BLACK
	BB72HC-1-F-S-27													STAINLESS
3	BB78HC-1-F-B	3/6	4	740	630	560	79	29.13	37.25	115	1/3	5.5	33.59	BLACK
	BB78HC-1-F-S													STAINLESS FRONT
3	BB94HC-1-F-B	3/6	5	920	785	675	95	29.13	37.25	115	1/3	5.5	37.82	BLACK
	BB94HC-1-F-S													STAINLESS FRONT

Depth measurement includes handles. BB24 height measurement includes mounting height.

### AVAILABLE TOPS



**1.5-INCH STAINLESS STEEL TOP**  
indicated with green model #  
example: **BB58HC-1-F-B**



**2-INCH STAINLESS STEEL TOP**  
indicated with black model # and "-27"  
example: **BB48HC-1-F-B-27**



**GALVANIZED SUB-TOP**  
indicated with black model #  
example: **BB48HC-1-F-B**

**GLASS DOORS (HINGED)**

MAINTAINS PRODUCT TEMPERATURES OF 36-38°F.

SECTIONS	MODEL #	DOORS/SHELVES	# OF STRAIGHT WALL KEGS	12oz CANS	12oz BOTTLES	LONGNECK BOTTLES	WIDTH	DEPTH	HEIGHT	VOLTS	HP	AMPS	CUBIC FEET	COLOR
1	BB24HC-1-FG-B	1/2	1	180	140	110	24	30.13	37.75	115	1/6	2	7.66	BLACK
	BB24HC-1-FG-S													STAINLESS FRONT
1	BB36HC-1-FG-B	1/2	1	240	220	170	36	24.5	34	115	1/4	2.5	8.36	BLACK
	BB36HC-1-FG-S													STAINLESS
1	BB36HC-1-FG-B-27	1/2	1	240	220	170	36	24.5	36	115	1/4	2.5	8.36	BLACK
	BB36HC-1-FG-S-27													STAINLESS
2	BB48HC-1-FG-B	2/4	2	288	300	325	48	24.5	34	115	1/4	2.5	12.4	BLACK
	BB48HC-1-FG-S													STAINLESS
2	BB48HC-1-FG-B-27	2/4	2	288	300	325	48	24.5	36	115	1/4	2.5	12.4	BLACK
	BB48HC-1-FG-S-27													STAINLESS
2	BB58HC-1-FG-B	2/4	2	528	440	365	59	29.13	37.25	115	1/4	2.5	21.86	BLACK
	BB58HC-1-FG-S													STAINLESS FRONT
2	BB68HC-1-FG-B	2/4	3	672	550	435	69	29.13	37.25	115	1/3	5.3	25.93	BLACK
	BB68HC-1-FG-S													STAINLESS FRONT
3	BB72HC-1-FG-B	3/6	3	540	480	505	72	24.5	34	115	1/3	3.1	19.92	BLACK
	BB72HC-1-FG-S													STAINLESS
3	BB72HC-1-FG-B-27	3/6	3	540	480	505	72	24.5	36	115	1/3	3.1	19.92	BLACK
	BB72HC-1-FG-S-27													STAINLESS
3	BB78HC-1-FG-B	3/6	4	740	630	560	79	29.13	37.25	115	1/3	5.5	33.59	BLACK
	BB78HC-1-FG-S													STAINLESS FRONT
3	BB94HC-1-FG-B	3/6	5	920	785	675	95	29.13	37.25	115	1/3	5.5	37.82	BLACK
	BB94HC-1-FG-S													STAINLESS FRONT

Depth measurement includes handles. BB24 height measurement includes mounting height.

**GLASS DOORS (SLIDING)** (Door frame only comes in black)

MAINTAINS PRODUCT TEMPERATURES OF 36-38°F.

SECTIONS	MODEL #	DOORS/SHELVES	# OF STRAIGHT WALL KEGS	12oz CANS	12oz BOTTLES	LONGNECK BOTTLES	WIDTH	DEPTH	HEIGHT	VOLTS	HP	AMPS	CUBIC FEET	COLOR
2	BB48HC-1-F-GS-B	2/4	2	288	300	325	48	23.63	34	115	1/4	2.5	12.4	BLACK
	BB48HC-1-F-GS-S													STAINLESS
2	BB48HC-1-F-GS-B-27	2/4	2	288	300	325	48	23.63	36	115	1/4	2.5	12.4	BLACK
	BB48HC-1-F-GS-S-27													STAINLESS
2	BB58HC-1-F-GS-B	2/4	2	528	440	365	59	28.25	37.25	115	1/4	2.5	21.86	BLACK
	BB58HC-1-F-GS-S													STAINLESS FRONT
3	BB72HC-1-F-GS-B	3/6	3	540	480	505	72	23.63	34	115	1/3	3.1	19.92	BLACK
	BB72HC-1-F-GS-S													STAINLESS
3	BB72HC-1-F-GS-B-27	3/6	3	540	480	505	72	23.63	36	115	1/3	3.1	19.92	BLACK
	BB72HC-1-F-GS-S-27													STAINLESS

Depth measurement includes handles.

# BACK BAR COOLERS

## Food Rated Pass-thru

### SOLID DOORS

MAINTAINS PRODUCT TEMPERATURES OF 36-38°F.

SECTIONS	MODEL #	DOORS/ SHELVES	# OF STRAIGHT WALL KEGS	12oz CANS	12oz BOTTLES	LONGNECK BOTTLES	WIDTH	DEPTH	HEIGHT	VOLTS	HP	AMPS	CUBIC FEET	COLOR
2	BB48HC-1-F-PT-B	4/4	2	288	300	325	48	27.38	34	115	1/3	3.1	13.6	BLACK
	BB48HC-1-F-PT-S													STAINLESS
2	BB48HC-1-F-PT-B-27	4/4	2	288	300	325	48	27.38	36	115	1/3	3.1	13.6	BLACK
	BB48HC-1-F-PT-S-27													STAINLESS
3	BB72HC-1-F-PT-B	6/6	3	540	480	505	72	27.38	34	115	1/3	3.1	22.1	BLACK
	BB72HC-1-F-PT-S													STAINLESS
3	BB72HC-1-F-PT-B-27	6/6	3	540	480	505	72	27.38	36	115	1/3	3.1	22.1	BLACK
	BB72HC-1-F-PT-S-27													STAINLESS

*Depth measurement includes handles.*



**GLASS DOORS (HINGED)**

MAINTAINS PRODUCT TEMPERATURES OF 36-38°F.

SECTIONS	MODEL #	DOORS/SHELVES	# OF STRAIGHT WALL KEGS	12oz CANS	12oz BOTTLES	LONGNECK BOTTLES	WIDTH	DEPTH	HEIGHT	VOLTS	HP	AMPS	CUBIC FEET	COLOR
2	BB48HC-1-FG-PT-B	4/4	2	288	300	325	48	27.38	34	115	1/3	3.1	13.6	BLACK
	STAINLESS													
2	BB48HC-1-FG-PT-B-27	4/4	2	288	300	325	48	27.38	36	115	1/3	3.1	13.6	BLACK
	STAINLESS													
3	BB72HC-1-FG-PT-B	6/6	3	540	480	505	72	27.38	34	115	1/3	3.1	22.1	BLACK
	STAINLESS													
3	BB72HC-1-FG-PT-B-27	6/6	3	540	480	505	72	27.38	36	115	1/3	3.1	22.1	BLACK
	STAINLESS													

Depth measurement includes handles.

**GLASS DOORS (SLIDING)** *(Door frame only comes in black)*

MAINTAINS PRODUCT TEMPERATURES OF 36-38°F.

SECTIONS	MODEL #	DOORS/SHELVES	# OF STRAIGHT WALL KEGS	12oz CANS	12oz BOTTLES	LONGNECK BOTTLES	WIDTH	DEPTH	HEIGHT	VOLTS	HP	AMPS	CUBIC FEET	COLOR
2	BB48HC-1-GS-F-PT-B	4/4	2	288	300	325	48	25.75	34	115	1/3	3.1	13.6	BLACK
	STAINLESS													
2	BB48HC-1-GS-F-PT-B-27	4/4	2	288	300	325	48	25.75	36	115	1/3	3.1	13.6	BLACK
	STAINLESS													
3	BB72HC-1-GS-F-PT-B	6/6	3	540	480	505	72	25.75	34	115	1/3	3.1	22.1	BLACK
	STAINLESS													
3	BB72HC-1-GS-F-PT-B-27	6/6	3	540	480	505	72	25.75	36	115	1/3	3.1	22.1	BLACK
	STAINLESS													

Depth measurement includes handles.

**AVAILABLE TOPS**



**2-INCH STAINLESS STEEL TOP**  
indicated with black model # and "-27"  
*example: BB48HC-1-FG-PT-B-27*



**GALVANIZED SUB-TOP**  
indicated with black model #  
*example: BB48HC-1-FG-PT-B*

# BOTTLE COOLERS



**Heavy-duty sliding lids**

**3 year parts and labor warranty  
with an additional 4 year  
compressor part warranty**

**Made in USA**

**Galvanized steel interior and floor**

**Full electronic temperature control**

**100% Metal lids**  
reinforced to prevent bowing

**Stainless steel top**

**Bottle opener and cap catcher standard**

**Adjustable wire dividers**



**ADJUSTABLE DIVIDERS**  
to organize cooler to meet your specific needs



**100% METAL LIDS**  
reinforced to prevent bowing



**FROSTY BREW™ 30-32°**

MAINTAINS PRODUCT TEMPERATURES OF 30-32°F.

MODEL #	LIDS/ DIVIDERS	WIDTH	DEPTH	HEIGHT	VOLTS	HP	AMPS	CUBIC FEET	COLOR
DW49HC-B-29	2/3	50	26.5	33.75	115	1/4	2.5	13.7	BLACK
DW49HC-S-29									STAINLESS FRONT
DW64HC-B-29	2/4	65	26.5	33.75	115	1/4	2.5	18.5	BLACK
DW64HC-S-29									STAINLESS FRONT
DW79HC-B-29	3/5	80	26.5	33.75	115	1/4	2.5	24.1	BLACK
DW79HC-S-29									STAINLESS FRONT
DW94HC-B-29	4/6	95	26.5	33.75	115	1/4	2.5	28.63	BLACK
DW94HC-S-29									STAINLESS FRONT

Depth measurement includes handles. Height measurement includes mounting height.

**STANDARD 36-40°**

MAINTAINS PRODUCT TEMPERATURES OF 36-40°F.

MODEL #	LIDS/ DIVIDERS	WIDTH	DEPTH	HEIGHT	VOLTS	HP	AMPS	CUBIC FEET	COLOR
SF34HC-B	1/2	34.88	26.5	33.63	115	1/10	1.2	7.5	BLACK
SF34HC-S									STAINLESS FRONT
DW49HC-B	2/3	50	26.5	33.75	115	1/4	2.5	13.7	BLACK
DW49HC-S									STAINLESS FRONT
DW64HC-B	2/4	65	26.5	33.75	115	1/4	2.5	18.5	BLACK
DW64HC-S									STAINLESS FRONT
DW79HC-B	3/5	80	26.5	33.75	115	1/4	2.5	24.1	BLACK
DW79HC-S									STAINLESS FRONT
DW94HC-B	4/6	95	26.5	33.75	115	1/4	2.5	28.63	BLACK
DW94HC-S									STAINLESS FRONT

Depth measurement includes handles. Height measurement includes mounting height.

**ACCESS OPTIONS**

- Metal lids

**EXTERIOR FINISHES**

- Black
- Stainless Steel

**INTERIOR FINISHES**

- Galvanized steel
- Stainless steel

**AVAILABLE OPTIONS**

- Remote models available

**AVAILABLE ACCESSORIES**

- Frosty brew model (30-32° F)
- Extra wide dividers
- Locks

**MOUNTING OPTIONS**

- 3" casters
- 6" legs

**AGENCY CERTIFICATIONS**





# GLASS & PLATE CHILLERS



**Heavy-duty sliding lids**

**3 year parts and labor warranty  
with an additional 4 year  
compressor part warranty**

**Made in USA**

**Front or top loading**

**Interior thermometer**

**Self-closing door with 120° stay-open feature**  
(Front Loading Models)

**Field-reversible door**  
(Front Loading Models)

**Easy door removal**  
for service and cleaning (Top Loading)

**Magnetic gasket attached to each door**  
for positive seal

**Auto-defrost**

**Built-in Condensate Evaporator System**

**Operating Temperature -10F**

**Two Epoxy Coated Shelves**

**R290 Refrigerant**



**ADJUSTABLE DIVIDERS**

to organize cooler to meet your specific needs



**100% METAL LIDS**

reinforced to prevent bowing (GF models)

**FRONT LOADING**

CHILLS TO 0°F, PRODUCING FROST WHEN REMOVED

MODEL #	DOORS/ SHELVES	CASE CAPACITY		WIDTH	DEPTH	HEIGHT	VOLTS	HP	AMPS	CUBIC FEET	COLOR
		12oz MUGS	8" PLATES								
FLG24HC-1-B	1/2	80	100	24	30.13	32	115	1/4	2.5	5.06	BLACK
FLG24HC-1-S											STAINLESS

**Front breathing**

needs no installation clearances on the side, back or bottom

*Depth measurement includes handles.*



**TOP LOADING**

CHILLS TO 0°F, PRODUCING FROST WHEN REMOVED

MODEL #	LIDS/ DIVIDERS	CASE CAPACITY		WIDTH	DEPTH	HEIGHT	VOLTS	HP	AMPS	CUBIC FEET	COLOR
		12oz MUGS	8" PLATES								
GF24HC-B	1/2	76	100	24	26.13	33.63	115	1/2	3.5	4	BLACK
GF24HC-S											STAINLESS
GF34HC-B	1/2	94	150	34	26.13	33.63	115	1/2	3.5	6.4	BLACK
GF34HC-S											STAINLESS
GF48HC-B	2/4	164	250	48	26.13	33.63	115	1/2	3.5	9.65	BLACK
GF48HC-S											STAINLESS

*Depth measurement includes handles.*

**ACCESS OPTIONS**

- Doors
- Metal lids

**EXTERIOR FINISHES**

- Black
- Stainless Steel

**INTERIOR FINISHES**

- Galvanized steel with reinforced stainless steel floor
- Stainless steel

**AVAILABLE OPTIONS**

- Remote models available

**AVAILABLE ACCESSORIES**

- Locks factory installed available for GF24L & GF34L

**MOUNTING OPTIONS**

- 6" legs (GF models only)

**AGENCY CERTIFICATIONS**



## Bar & Wine Accessories

DESCRIPTION	UNIT(S)	PART NUMBER
<b>SHELVING / ORGANIZERS</b>		
Epoxy Coated Wire Shelf	DD48	403-322D
Epoxy Coated Wire Shelf	DD50/50C Shelf Kit (set of 2)	00C21-022A
Epoxy Coated Wire Shelf	DD58 Shelf Kit (set of 2)	00C21-007A--
Epoxy Coated Wire Shelf	DD68 Shelf Kit (set of 2)	00C21-006A--
Epoxy Coated Wire Shelf	DD72	403-326D
Epoxy Coated Wire Shelf	DD78 Shelf Kit (set of 3)	00C21-023A
Epoxy Coated Wire Shelf	DD94 Left/Right Shelf	403-216D
Epoxy Coated Wire Shelf	DD94 Center Shelf	403-249D
Epoxy Coated Wire Shelf	BB24	403-943D-02
Epoxy Coated Wire Shelf	BB36	403-924D-02
Epoxy Coated Wire Shelf	BB48/48G	403-322D
Epoxy Coated Wire Shelf	BB58/58G	403-582D
Epoxy Coated Wire Shelf	BB68/68G	403-216D (RH) 403-249D (LH)
Epoxy Coated Wire Shelf	BB72/72G	403-326D
Epoxy Coated Wire Shelf	BB78/78G CTR	403-582D
Epoxy Coated Wire Shelf	BB78/78G RH	403-584D
Epoxy Coated Wire Shelf	BB94/94G CTR	403-216D
Epoxy Coated Wire Shelf	BB94/94G RH	403-249D
Epoxy Coated Wire Shelf	DP46/67/93/119, DPD46/67/93/119	403-834D
Shelf Clip	DD48/72/94	403-168A
Shelf Clip	All BB's	403-168A

DESCRIPTION	UNIT(S)	PART NUMBER
<b>MOUNTING</b>		
6" Caster	BB24/BB36	00C31-038A
6" Caster	BB48, BB72 (set of four)	00C31-038A
3" Caster	BB48, BB72 (set of four)	00C31-041A
3" Caster	BB58, BB68 (set of four)	00C26-012A
3" Caster	BB78, BB94 (set of six)	00C26-017A
3" Caster	DD36	00C31-041A
6" Caster	DD36	00C31-038A
6" Caster	DD48, DD72 (set of four)	00C31-038A
3" Caster	DD48, DD72 (set of four)	00C31-041A
3" Caster	DD50, DD58, DD68 (set of four)	00C26-012A
3" Caster	DD78, DD94 (set of six)	00C26-017A
3" Caster	DW49 (set of four)	00C31-034ABB
3" Caster	DW64 (set of four)	00C31-031ABB
3" Caster	DW79, DW94 (set of six)	00C31-030ABB
6" Adjustable with Plate	DW49 (set of four)	00C31-036A--
6" Adjustable with Plate	DW64 (set of four)	00C31-033ABB
6" Adjustable with Plate	DW79, 94 (set of six)	00C31-032ABB
6" Adjustable with Plate	SF34 (set of four)	00C31-035AAA
Leg Accessory Kit	BM23 (set of four)	00C06-002A--
6" Adjustable with Plate	GF24, 34, 48 (set of four)	00C31-035AAA
6" Black Leg	BB/DD 24, 36, 48, 72 (set of four)	58B02-001A
6" Adjustable with Plate	BB58, 68, DD50, 58, 68 (set of four)	00C26S014A
6" Adjustable with Plate	BB/DD 78, 94 (set of six)	00C26S015A
<b>LID LOCKS</b>		
Lid Lock	GF24/34	00C30-100A
Lid Lock	GF48	00C30-101A
Lid Lock	SF34	00C30-031ABB
Lid Lock	DW49 Solid Lid	00C30-030AAA
Lid Lock	DW64 Solid Lid	00C30-029AAA
Lid Lock	DW79 Solid Lid	00C30-028AAA
Lid Lock (2 required for DW94)	DW94 Solid Lid	00C30-030AAA

## Bar & Wine Accessories

DESCRIPTION	UNIT(S)	PART NUMBER
<b>TAPS / FAUCETS / MANIFOLDS</b>		
Hole cover for cut out on DD units	ALL DD UNITS	00C10-006A
1 Tap 3" OD Beer Faucet	ALL DD UNITS	406-053A
1 Tap 2 1/2" OD Beer/Wine Faucet	ALL DD UNITS	406-004A--
2 Tap 3" OD Beer/Wine Faucet	ALL DD UNITS	406-054A
3 Tap 3" OD Beer/Wine Faucet	ALL DD UNITS	406-055A
4 Tap 3" OD Beer/Wine Faucet	ALL DD UNITS	406-064A
5 Tap 3" OD Beer/Wine Faucet	ALL DD UNITS	406-075A
Single Faucet Adapter	ALL DD UNITS	406-056A
Double Faucet Adapter	ALL DD UNITS	406-057A
2 Way Manifold	ALL DD UNITS	402-188A--
3 Way Manifold	ALL DD UNITS	402-189A--
4 Way Manifold	ALL DD UNITS	402-191A
<b>ADDITIONAL ACCESSORIES</b>		
Wire Divider (Step)	DW UNITS	403-114D
Wire Divider (Adjustable)	DW UNITS	403-113D
Wire Divider Spring	DW UNITS	401-090AAB
Cap Catcher (black)	DW & SF UNITS	09B30S025C
Draft Arm Faucet Lock (slide on)	ALL DD UNITS	401-909A
Glass Rinser	ALL DD UNITS	406-067A







### Super Bright RGB LED Liquor Shelves

- 50,000 hours minimum life
- Environmentally friendly: no mercury, lead or toxic gases
- Color-rich, programmable LED's
- Available up to 8' Long
- 44 Key RGB Wireless Remote Control to control unlimited colors with multiple lighting effects
- Independent level control: choose colors for each step independent of the others
- Plugs into any standard wall outlet
- Modular Construction
- Includes UL listed power supply
- 100% Black Acrylic bottle tiers. Glossy black on front and sides with frosted acrylic tops.

DESCRIPTION	PART NUMBER
2' LED Liquor Shelf, 24"L X 4.5"W X .75" Thick, 2 wall brackets	<b>LS2-24L</b>
3' LED Liquor Shelf, 36"L X 4.5"W X .75" Thick, 2 wall brackets	<b>LS3-36L</b>
4' LED Liquor Shelf, 48"L X 4.5"W X .75" Thick, 3 wall brackets	<b>LS4-48L</b>
5' LED Liquor Shelf, 60"L X 4.5"W X .75" Thick, 4 wall brackets	<b>LS5-60L</b>
6' LED Liquor Shelf, 72"L X 4.5"W X .75" Thick, 5 wall brackets	<b>LS6-72L</b>
2' Double Wide LED Liquor Shelf, 24"L X 9"W X .75" Thick, 2 wall brackets	<b>LS2-24L-DW</b>
3' Double Wide LED Liquor Shelf, 36"L X 9"W X .75" Thick, 2 wall brackets	<b>LS3-36L-DW</b>
4' Double Wide LED Liquor Shelf, 48"L X 9"W X .75" Thick, 3 wall brackets	<b>LS4-48L-DW</b>
5' Double Wide LED Liquor Shelf, 60"L X 9"W X .75" Thick, 4 wall brackets	<b>LS5-60L-DW</b>
6' Double Wide LED Liquor Shelf, 72"L X 9"W X .75" Thick, 5 wall brackets	<b>LS6-72L-DW</b>
2' Two Tier LED Bottle Display, 24"L X 9"D X 8"H	<b>LBD2-24L</b>
3' Two Tier LED Bottle Display, 36"L X 9"W X 8"H	<b>LBD2-36L</b>
4' Two Tier LED Bottle Display, 48"L X 9"W X 8"H	<b>LBD2-48L</b>
5' Two Tier LED Bottle Display, 60"L X 9"W X 8"H	<b>LBD2-60L</b>
6' Two Tier LED Bottle Display, 72"L X 9"W X 8"H	<b>LBD2-72L</b>
2' Three Tier LED Bottle Display, 24"L X 13.5"D X 12"H	<b>LBD3-24L</b>
3' Three Tier LED Bottle Display, 36"L X 13.5"D X 12"H	<b>LBD3-36L</b>
4' Three Tier LED Bottle Display, 48"L X 13.5"D X 12"H	<b>LBD3-48L</b>
5' Three Tier LED Bottle Display, 60"L X 13.5"D X 12"H	<b>LBD3-60L</b>
6' Three Tier LED Bottle Display, 72"L X 13.5"D X 12"H	<b>LBD3-72L</b>
2' Four Tier LED Bottle Display, 24"L X 18"W X 16"H	<b>LBD4-24L</b>
3' Four Tier LED Bottle Display, 36"L X 18"W X 16"H	<b>LBD4-36L</b>
4' Four Tier LED Bottle Display, 48"L X 18"W X 16"H	<b>LBD4-48L</b>
5' Four Tier LED Bottle Display, 60"L X 18"W X 16"H	<b>LBD4-60L</b>
6' Four Tier LED Bottle Display, 72"L X 18"W X 16"H	<b>LBD4-72L</b>







# MILK COOLERS

MADE TO DELIVER CONSISTENT PERFORMANCE DURING REPEATED ACCESS

**Cold Wall**



**Forced Air**



# MILK COOLERS



**One-piece bottom for maximum support**

**3 year parts and labor warranty with an additional 4 year compressor part warranty**

**Made in USA**

**CFC & HCFC-free insulation is foamed-in-place**  
for increased structural strength & energy efficiency

**Epoxy coated, steel wire racks included**  
for added floor protection

**Flexible compression door gaskets**  
ensure a tight seal for added temperature control

**Cylinder Locks**

**Bottom drain for connection to drain hose and easy cleaning**

**External digital thermometer**

**Coolers hold milk between 36°-38°F**  
until ready to serve for maximum refreshment



**ONE-PIECE REINFORCED FLOOR**  
for maximum milk crate support and made with stainless steel



**SINGLE AND DUAL ACCESS**  
models available

**COLD WALL - SINGLE ACCESS**

MAINTAINS PRODUCT TEMPERATURES OF 32-40°F.

MODEL #	CASE CAPACITY		WIDTH	DEPTH	HEIGHT	VOLTS	HP	AMPS	CUBIC FEET	EXTERIOR FINISH	INTERIOR FINISH
	13 X 13 X 11"	19 X 13 X 11"									
SM34HC-S	8	4	34	30.63	41.13	115	1/3	2.2	12.73	STAINLESS	STAINLESS
SM34HC-W										WHITE	GALVANIZED
SM34HC-W-02										WHITE	STAINLESS
SM49HC-S	12	8	49	30.63	41.13	115	1/3	2.2	20.32	STAINLESS	STAINLESS
SM49HC-W										WHITE	GALVANIZED
SM49HC-W-02										WHITE	STAINLESS
SM58HC-S	16	10	58	30.63	41.13	115	1/3	2.2	22.63	STAINLESS	STAINLESS
SM58HC-W										WHITE	GALVANIZED
SM58HC-W-02										WHITE	STAINLESS

Depth measurement includes handles. Height measurement includes mounting height.

**FORCED AIR - SINGLE ACCESS**

MAINTAINS PRODUCT TEMPERATURES OF 32-40°F.

MODEL #	CASE CAPACITY		WIDTH	DEPTH	HEIGHT	VOLTS	HP	AMPS	CUBIC FEET	EXTERIOR FINISH	INTERIOR FINISH
	13 X 13 X 11"	19 X 13 X 11"									
SMF34HC-1-S	8	4	34	33.63	46.88	115	1/4	1.87	13.59	STAINLESS	STAINLESS
SMF34HC-1-W										WHITE	GALVANIZED
SMF34HC-1-W-02										WHITE	STAINLESS
SMF49HC-1-S	12	8	49	33.63	46.88	115	1/4	2.46	19.66	STAINLESS	STAINLESS
SMF49HC-1-W										WHITE	GALVANIZED
SMF49HC-1-W-02										WHITE	STAINLESS
SMF58HC-1-S	16	10	58	33.63	46.88	115	1/4	2.46	24	STAINLESS	STAINLESS
SMF58HC-1-W										WHITE	GALVANIZED
SMF58HC-1-W-02										WHITE	STAINLESS

Depth measurement includes handles. Height measurement includes mounting height.

**ACCESS OPTIONS**

- Metal lids

**EXTERIOR FINISHES**

- White coated steel
- Stainless steel

**INTERIOR FINISHES**

- Galvanized steel
- Stainless steel

**AVAILABLE ACCESSORIES**

- Cow Spot graphics
- Custom graphics available
- Corner & Wrap-around bumpers

**MOUNTING OPTIONS**

- 4" casters (SM models only)
- 6" casters (SMF models only)

**AGENCY CERTIFICATIONS**



# MILK COOLERS

## COLD WALL - DUAL ACCESS

MAINTAINS PRODUCT TEMPERATURES OF 32-40°F.

MODEL #	CASE CAPACITY		WIDTH	DEPTH	HEIGHT	VOLTS	HP	AMPS	CUBIC FEET	EXTERIOR FINISH	INTERIOR FINISH
	13 X 13 X 11"	19 X 13 X 11"									
ST34HC-S	8	4	34	31.25	41.13	115	1/2	3.7	12.37	STAINLESS	STAINLESS
ST34HC-W										WHITE	GALVANIZED
ST34HC-W-02										WHITE	STAINLESS
ST49HC-S	12	8	49	31.25	41.13	115	1/2	3.7	18.97	STAINLESS	STAINLESS
ST49HC-W										WHITE	GALVANIZED
ST49HC-W-02										WHITE	STAINLESS
ST58HC-S	16	10	58	31.25	41.13	115	1/2	3.7	22.5	STAINLESS	STAINLESS
ST58HC-W										WHITE	GALVANIZED
ST58HC-W-02										WHITE	STAINLESS

Depth measurement includes handles. Height measurement includes mounting height.

## FORCED AIR - DUAL ACCESS

MAINTAINS PRODUCT TEMPERATURES OF 32-40°F.

MODEL #	CASE CAPACITY		WIDTH	DEPTH	HEIGHT	VOLTS	HP	AMPS	CUBIC FEET	EXTERIOR FINISH	INTERIOR FINISH
	13 X 13 X 11"	19 X 13 X 11"									
STF49HC-1-S	12	8	49	34	47.75	115	1/4	2.46	20.55	STAINLESS	STAINLESS
STF49HC-1-W										WHITE	GALVANIZED
STF49HC-1-W-02										WHITE	STAINLESS
STF58HC-1-S	16	10	58	34	47.75	115	1/4	2.46	24.3	STAINLESS	STAINLESS
STF58HC-1-W										WHITE	GALVANIZED
STF58HC-1-W-02										WHITE	STAINLESS

Depth measurement includes handles. Height measurement includes mounting height.

DESCRIPTION	UNIT(S)	PART NUMBER
<b>MOUNTING</b>		
4" Plate Caster (standard)	SM/ST 34,49,58 (per caster-2 required per cabinet)	401-094A--
4" Plate Caster w/brake (standard)	SM/ST 34,49,58 (per caster-2 required per cabinet)	401-099A--
7" Plate Caster (standard)	SMF34,SMF49,SMF58 (per caster-2 required per cabinet)	401-519A
7" Plate Caster w/brake (standard)	SMF34,SMF49,SMF58 (per caster-2 required per cabinet)	401-520A
5" Plate Caster w/brake (standard)	STF49/STF58 (per caster-2 required per cabinet)	401-127A--
5" Plate Caster (standard)	STF49/STF58 (per caster-2 required per cabinet)	401-209A
6" Adjustable with Plate	SM34,49,58 ST34,49,58 ( set of four)	00C06-003A

<b>BUMPERS</b> <i>(Require field tapping and installation)</i>		
Wrap Around Bumpers	SM34 / ST34	00C01-004A--
Wrap Around Bumpers	SM49 / ST49	00C01-005A--
Wrap Around Bumpers	SM58 / ST58	00C01-006A--
Wrap Around Bumpers	SMF34 / STF34	00C01-009A--
Wrap Around Bumpers	SMF49 / STF49	00C01-010A
Wrap Around Bumpers	SMF58 / STF58	00C01-011A
Corner Bumpers (single)	All Milk Coolers	703-868A
Corner Bumpers (Set of 4)	Corner Bumper Kit (set of 4)	00C01-012A-01

<b>DECALS</b>		
Base Kit (Cow Spots)	SM34, ST34, SMF34	807-836C
1 Base Kit (Cow Spots)	SM49, ST49, SMF49	807-836C
Supplemental Kit (Cow Spots)	SM49, ST49, SMF49	807-837C
1 Base Kit (Cow Spots)	SM58, ST58, SMF58	807-836C
Supplemental Kit (Cow Spots)	SM58, ST58, SMF58 (2 kits required)	807-837C
Got Milk Lid Decal	SMF/SM/ST34	807-839C-001
Got Milk Lid Decal	SMF/SM/ST49	807-839C-002
Got Milk Lid Decal	SMF/SM/ST58	807-839C-003
Got Milk Lid Decal	STF49	807-839C-004
Got Milk Lid Decal	STF58	807-839C-005
Got Milk Door Decal	SMF/SM/ST34	807-839C-006
Got Milk Door Decal	SMF/SM/ST49	807-839C-007
Got Milk Door Decal	SMF/SM/ST58	807-839C-008





# BLAST CHILLERS / SHOCK FREEZERS

RAPID CHILLING FOR OPTIMAL FOOD SAFETY AND KITCHEN EFFICIENCY



**Self Contained**



**Remote**

# BLAST CHILLERS/SHOCK FREEZERS

Self Contained



**Compact construction**

**Electronic control board display**

**Custom chill/freeze cycles**

**Core temperature probe**

**Manual defrost**

**Insulation is CFC and HCFC free,  
high density polyurethane**

**R404A refrigeration**

**Self-contained refrigeration**

**3 Year parts and labor / Additional 2 year  
compressor part warranty**

**Automatic product storing at end of cycle**

**Up to 99 custom programmable cycles**

**USB Port for HACCP report download**



## CORE PROBE

measures product temperature



## ELECTRONIC CONTROL DISPLAY

intuitive programmable display

**WHAT IS BLAST CHILLING AND FREEZING?**

Blast Chilling extracts the heat out of food, rapidly lowering the temperature. Department of Health guidelines require that all food temperatures be reduced from 150°F to 38°F degrees within a 90 minute period to keep food out of the “danger zone” of 145°F to 46°F, where bacteria multiplies fast.

Blast freezing rapidly lowers food temperatures from 150°F to 0°F vs. chilling temperatures above.

**WHAT IS SOFT CHILL?**

The Soft Chill cycle is ideal for the rapid, but gentle chilling of any dish (i.e., rice, pasta, fish, and fruit). This cycle brings the temperature of the food down while maintaining positive air temperatures of 37°F or above. This prevents ice crystals from forming that can damage the structure of delicate foods and allows for delicate foods to keep their brilliant colors.

**WHAT IS HARD CHILL?**

The Hard Chill cycle is ideal for chilling “standard products” such as cooked meat, lasagna, and individually portioned meals.

**BENEFITS OF BLAST CHILLING**

- Always serve fresh, top quality products
- Color, texture, and nutritional value are locked in
- The fast cooling process of blast chilling dramatically reduces bacteria reproduction, minimizing food spoilage
- Delicate foods like rice, pasta, fish, and fruit are protected
- Kitchen Efficiency – Saves Time & Money
- Allows advance food prep by preparing larger batches that can be refrigerated or frozen for later use
- Can enhance profits by increasing product capacity and reducing food waste
- Allows left over food from serving line to be quickly and safely chilled for later use
- Use Blast Chiller/Freezers on raw or cooked food

**BLAST CHILLER/SHOCK FREEZERS**

MODEL #	PAN CAPACITY	CHILLING CYCLE	CHILLING CAPACITY	WIDTH	DEPTH	HEIGHT	VOLTS	AMPS	CUBIC FEET
CF031AG	3 - 12x20"	194° to 37° F (90 minutes)	17.6 lbs	22.05	27.6	20.47	115-120	9.9	7.3
		194° to 0° F (240 minutes)	11 lbs						

*Depth measurement includes handles. Height measurement includes mounting height.*

**BLAST CHILLER/SHOCK FREEZERS**

**Self-closing doors**

with still position at 100 degrees

**Ergonomic handles**

**6" legs standard**

MODEL #	PAN CAPACITY	CHILLING CYCLE	CHILLING CAPACITY	WIDTH	DEPTH	HEIGHT	VOLTS	AMPS
BF054AP	5 - 12x20"	194° to 37° F (90 minutes)	45 lbs	33.46	29.92	33.46	208-240 6-15P	66
		194° to 0° F (240 minutes)	30 lbs					
BF084AP	8 - 12x20" or 4 - 18x26"	194° to 37° F (90 minutes)	70 lbs	33.46	33.46	52	208-240 6-15P	10.1
		194° to 0° F (240 minutes)	40 lbs					
BF124AP	12 - 12x20" or 6 - 18x26"	194° to 37° F (90 minutes)	100 lbs	33.46	33.46	70.87	208-240 15-20P	9
		194° to 0° F (240 minutes)	70 lbs					
BF164AP	16 - 12x20" or 8 - 18x26"	194° to 37° F (90 minutes)	140 lbs	33.46	33.46	76.75	208-240 15-20P	13.2
		194° to 0° F (240 minutes)	100 lbs					
BF122AP	24 - 12x20" or 12 - 18x26"	194° to 37° F (90 minutes)	200 lbs	43.31	34.85	70.87	208-240 15-30P	24
		194° to 0° F (240 minutes)	140 lbs					

*Depth measurement includes handles. Height measurement includes mounting height.*

**FINISHES**

- Stainless steel interior and exterior

**ACCESSORIES**

- UV Lamp (must be added at time of order)

**AGENCY CERTIFICATIONS**



# REMOTE BLAST CHILLERS/SHOCK FREEZERS

## Roll-in and Roll-thru Cabinets



*Shown with optional ramp*

**Snap in place magnetic gaskets self closing door with hold open stop at 100°**

**On board recipe book with 99 free memory positions for custom programs**

**3 Year parts and labor / additional 2 year compressor part warranty**

**Stainless steel exterior and interior**

**Die-formed interior floor has rounded corners**

**Central drain for easy cleaning (select models)**

**Anti-condensation perimeter heating around door opening**

**Ergonomic door handle and stainless steel**

**Soft and hard, timed or core probe blast chilling**

**Multi point sensor temperature display button**

**HACCP alarm display button**

**Pre-cooling cycle button**

**Adjustable evaporator fan speed button**

**Manually initiated defrost, automatic termination**

**USB data recorder**

**Infinity mode program with adjustable set point (chilling only)**

**Automatic conservation mode at end of cycle**

**Contact factory for compatibility of refrigerants**



**AVAILABLE DOORS**

- Solid (one full-door)

**CONFIGURATIONS**

- Roll-in
- Roll-thru



*Shown with optional ramp*

**EXTERIOR FINISHES**

- Stainless steel

**INTERIOR FINISHES**

- Stainless steel

**AVAILABLE OPTIONS**

- Left hinge doors

**AVAILABLE ACCESSORIES**

- UV sterilization lamp (must be added at time of order)
- Single sensor probes (up to 4 possible)
- Stainless steel ramp

**AGENCY CERTIFICATIONS**



**CORE PROBE**

measures product temperature



**ELECTRONIC CONTROL DISPLAY**

intuitive programmable display

**AVAILABLE IN ROLL-IN OR ROLL-THRU**



*Shown with optional ramp*



# REMOTE BLAST CHILLERS/SHOCK FREEZERS

## ROLL-IN

MODEL #	CART CAPACITY	PAN SIZE	TEMP RANGE	LBS BC LBS SF	VOLTAGE	AMPS	BTU/HR (BASED ON R404A)
<b>BF201DP-1P</b> 47.25" x 45.25" x 87.75"	1	20 - 18" x 26" sheet pan cart or 20 - 12" x 20" steam pan cart	194/0	175-125	208-240	2.5	22014
<b>BF201AP-1P</b> 47.25" x 45.25" x 87.75"	1	20 - 18" x 26" sheet pan cart or 20 - 12" x 20" steam pan cart	194/0	230-155	208-240	5.7	24891
<b>BF202DP-1P</b> 47.25" x 76.75" x 87.75"	1	20 - 18" x 26" sheet pan cart or 40 - 12" x 20" steam pan cart	194/0	350-250	208-240	5.2	35584
<b>BF202AP-1P</b> 47.25" x 76.75" x 87.75"	1	20 - 18" x 26" sheet pan cart or 40 - 12" x 20" steam pan cart	194/0	465-300	208-240	7.9	44619
<b>BF402DP-1P</b> 59" x 92.5" x 87.75"	2	40 - 18" x 26" sheet pan cart or 80 - 12" x 20" steam pan cart	194/0	660-440	208-240	10.4	60070
<b>BF402AP-1P</b> 59" x 92.5" x 87.75"	2	40 - 18" x 26" sheet pan cart or 80 - 12" x 20" steam pan cart	194/0	925-595	208-240	15.8	73455
<b>BF602DP-1P</b> 59" x 131.88" x 87.75"	3	60 - 18" x 26" sheet pan cart or 120 - 12" x 20" steam pan cart	194/0	1000- 660	208-240	15.6	73455
<b>BF602AP-1P</b> 59" x 131.88" x 87.75"	3	60 - 18" x 26" sheet pan cart or 120 - 12" x 20" steam pan cart	194/0	1350- 900	208-240	23.7	114313

*Depth measurement includes handles, but does not include ramp(s)*

## ROLL-THRU

MODEL #	CART CAPACITY	PAN SIZE	TEMP RANGE	LBS BC LBS SF	VOLTAGE	AMPS	BTU/HR (BASED ON R404A)
<b>BF201DP-2P</b> 47.25" x 50.75" x 87.75"	1	20 - 18" x 26" sheet pan cart or 20 - 12" x 20" steam pan cart	194/0	175-125	208-240	2.5	22014
<b>BF201AP-2P</b> 47.25" x 50.75" x 87.75"	1	20 - 18" x 26" sheet pan cart or 20 - 12" x 20" steam pan cart	194/0	230-155	208-240	5.7	24891
<b>BF202DP-2P</b> 47.25" x 82.25" x 87.75"	1	20 - 18" x 26" sheet pan cart or 40 - 12" x 20" steam pan cart	194/0	350-250	208-240	5.2	35584
<b>BF202AP-2P</b> 47.25" x 82.25" x 87.75"	1	20 - 18" x 26" sheet pan cart or 40 - 12" x 20" steam pan cart	194/0	465-300	208-240	7.9	44619
<b>BF402DP-2P</b> 59" x 98" x 87.75"	2	40 - 18" x 26" sheet pan cart or 80 - 12" x 20" steam pan cart	194/0	660-440	208-240	10.4	60070
<b>BF402AP-2P</b> 59" x 98" x 87.75"	2	40 - 18" x 26" sheet pan cart or 80 - 12" x 20" steam pan cart	194/0	925-595	208-240	15.8	73455
<b>BF602DP-2P</b> 59" x 137.38" x 87.75"	3	60 - 18" x 26" sheet pan cart or 120 - 12" x 20" steam pan cart	194/0	1000- 660	208-240	15.6	73455
<b>BF602AP-2P</b> 59" x 137.38" x 87.75"	3	60 - 18" x 26" sheet pan cart or 120 - 12" x 20" steam pan cart	194/0	1350- 900	208-240	23.7	114313

*Depth measurement includes handles, but does not include ramp(s)*

**FRONT VIEW**

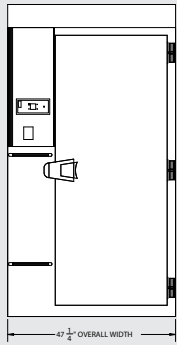

**SIDE VIEW: ROLL-INS**

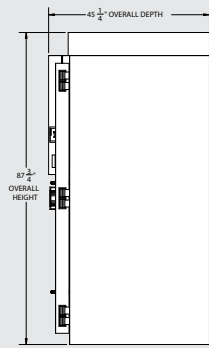

BF201DP-1P / BF201AP-1P

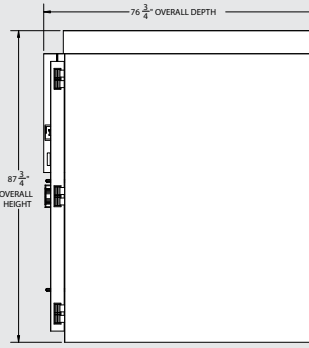

BF202DP-1P / BF202AP-1P

For Roll-Thru depths, add 5.5 inches

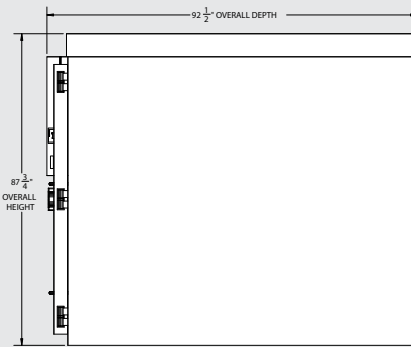
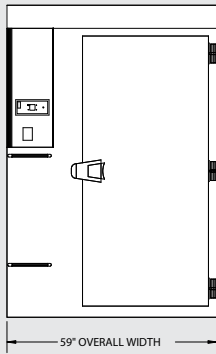

BF402DP-1P / BF402AP-1P

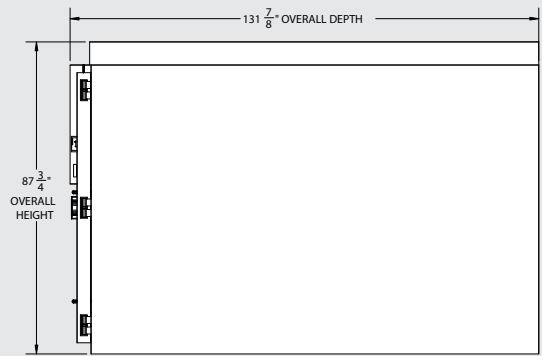

BF602DP-1P / BF602AP-1P

## Blast Chiller Accessories

DESCRIPTION	UNIT(S)	PART NUMBER
<b>MOUNTING</b>		
3.2" Casters	BF054AP	FR920596
5" Casters	BF084AP / BF124AP / BF164AP	FR920839
5" Casters	BF122AP	FR920735
<b>ADDITIONAL ACCESSORIES</b>		
Replacement probe for BF series	All BF Models	FR6638321
Secondary probe	All BF Models	FR966428
<b>RAMPS</b>		
Stainless steel ramp (order 2 for roll-thru models) 35.3" wide by 31.9" deep	BF201DP / BF201AP	FR960075
Stainless steel ramp (order 2 for roll-thru models) 39.2" wide by 31.9" deep	BF202DP and larger	FR960076
Stainless steel ramp 43.2" wide by 31.9" deep	BF200RB-PF0-XL	FR960077

# BLAST CHILLER/FREEZER/THAWER

## Self-Contained



*Shown with optional ramp*

**5" High Definition, Easy-To-Use Touch Display**  
**Blast Chilling, Shock Freezing, Thawing Mode**  
**Self-Contained R404A Refrigeration System**

### **Stainless Steel Exterior And Interior**

Rounded interior corners for proper cleaning

### **High Density, Polyurethane Insulation**

### **Hinged Door With Gasket**

with Closing Ramp System and Ergonomic Vertical Door Handle

### **Anti-Condensation Resistance**

Placed On The Door Under The Gasket

### **Stainless Steel Door Liner**

### **Thick Stainless Steel Internal Bumper**

to Avoid Damage Caused By The Cart

### **Die-Formed Leak-Proof Floor**

### **Heated Core Probe**

with 4 Measuring Points

### **Customized Blast Chilling, Blast Freezing and Thawing Cycles**

320 cycles can be memorized

### **USB Connection**

for Uploading And Downloading Data And Recipes



### **EXPANDABILITY AND CONTROL**

easily add, edit or rename recipes, all organized by product type and function



### **TOUCH CONTROL PHOTO MENU**

is easy to use, and the function selection is immediate and intuitive

**BLAST CHILLER/FREEZERS**

MODEL #	DOORS/ SHELVES	WIDTH	DEPTH	HEIGHT	VOLTS	HP	AMPS	CUBIC FEET	CHILLING CYCLE	CHILLING CAPACITY
<b>BF200RB-PF0-XL</b>	1/0	<b>43.31</b>	<b>64.25</b>	<b>94.5</b>	208	2.8	25.6	49.95	160° to 38° F (90 minutes)	187 lbs

*Depth measurement includes handles. Height measurement includes mounting height.*



**EXTERIOR FINISHES**

- Stainless steel

**INTERIOR FINISHES**

- Stainless steel

**AVAILABLE ACCESSORIES**

- UV sterilization system
- Additional Single Sensor Probe
- Stainless steel ramp

**INTERIOR SPACE CAPACITY**

- Maximum Interior Dimensions for Carts:  
35"W x 40"D x 71"H (not included)

**AGENCY CERTIFICATIONS**



# WARRANTY

## SALES TERMS

---

### PRICES & SPECIFICATIONS

Beverage-Air reserves the right to change the price and specifications of the equipment and/or material without notice. Prices are F.O.B. plant of manufacture.

### CANCELLATION

Buyer may cancel its order, reduce quantities, revise specifications, or extend schedules only by mutual agreement as to reasonable and proper cancellation charges which shall take into account expenses already incurred and commitment made by seller, and buyer shall indemnify seller against any loss.

### FREIGHT CLASS

All Beverage-Air products ship under 150 freight classification.

### CUSTOMER'S FREIGHT DAMAGE PROCEDURE

Before signing the carrier's freight bill the customer should do the following:

#### Visible Damage:

1. Inspect shipment for any damage. If you see damage or feel there may be concealed damage, mark the carrier's copy of the freight bill "damaged".
2. If there is damage to your shipment, action must be taken by you to notify Beverage-Air immediately. A freight claim must be filed with the carrier and an inspection scheduled by the carrier. It is the duty of the carrier to give you a written report upon notification. (VISIBLE AND CONCEALED).
3. For visible damage, where possible, do not accept delivery unless the condition noted on your copy of the freight bill and signed by the driver.

#### Concealed Damage:

If the damage is concealed, notify the carrier within 5 days of the receipt of the product by phone and in writing as well as Beverage Air. Ask them to send their agent to complete an inspection report. Retain all cartons and merchandise for inspection. It is critical that the customer take the above actions; without these steps claims for concealed damages may be denied.

### 3RD PARTY FREIGHT

3rd Party Freight shipments are FOB Beverage-Air and are not eligible for refusal at time of delivery. ALL 3rd PARTY SHIPMENTS ARE THE RESPONSIBILITY OF THE SHIPPER.

Claims for damaged product are to be filed by the shipper and Beverage-Air will not be liable. This product is not eligible for return to our warehouse facility.

### RETURN OF PRODUCT

**EQUIPMENT** - Prior Authorization must be granted by Beverage-Air before equipment can be returned for credit. Returns will only be authorized within 90 days of invoice date. Return authorizations are valid for 30 days. Equipment approved for return is subject to a 25% restocking charge.

Returned equipment must be shipped freight prepaid, packed in original carton, and received in good condition.

**PARTS** - Prior Authorization must be granted by Beverage-Air before parts can be returned for credit. Returns will only be authorized within 30 days of invoice date. Return authorizations are valid for 30 days. Parts approved for return are subject to a 25% or \$25.00 restocking charge (whichever is greater). Returned parts must be shipped freight prepaid, in the original packaging, and received in good condition.

## WARRANTY (Warranty valid in USA and Canada)

### THREE (3) YEAR PARTS AND LABOR WARRANTY:

Beverage-Air Corporation warrants to the original purchaser of Beverage-Air branded equipment, including all parts thereof, that such equipment is free from defects in material and workmanship, under normal use, proper maintenance, and service as indicated by Beverage-Air installation and operation instructions, for a period of three (3) years from the date of installation, or thirty-nine

(39) Months from the date of shipment from the manufacturer, whichever is earlier.

### ADDITIONAL FOUR (4) YEAR COMPRESSOR PART WARRANTY\*:

In addition to the warranty set forth above, Beverage-Air warrants the hermetically/semi-hermetically sealed compressor (part only) for an additional FOUR (4) years beyond the first three (3) years warranty period; not to exceed eighty-seven (87) months from the date of shipment from Beverage-Air, provided upon receipt of the compressor, manufacturer examination shows the sealed compressor to be defective. This extended warranty does not cover freight for the replacement compressor or freight for the return of the failed compressor.

\* Units shipped after 03/01/2020. Previous warranty applies to units shipped prior.

#### EXCEPTIONS:

- CT96 Models carry a one (1) year parts and labor warranty, limited to fifteen (15) months from date of shipment from Beverage-Air. These are excluded from additional compressor warranty.
- SR/SF (Slate) models carry a two (2) year parts and labor warranty, limited to twenty-seven (27) months from date of shipment from the Beverage-Air.
- Blast Chillers carry a three (3) year parts and labor warranty; additional two (2) years compressor part only.
- TMR/TMF carry a two (2) year parts and labor warranty, limited to twenty-seven (27) months from date of shipment from the Beverage-Air.
- Units installed in Residential applications will be not covered under this warranty. Units are intended for Commercial use only.

Also, this extended compressor-part only warranty does NOT apply to any electrical controls, condenser, evaporator, fan motors, overload switch, starting relay, capacitors, temperature control, filter/drier, accumulator, refrigeration tubing, wiring harness, labor charges, or supplies which are covered by the warranty above.

Normal wear type parts, such as light bulbs/lamps and gaskets are not covered by this warranty. For the purpose of this warranty, the original purchaser shall be deemed to mean the individual or company for who the product was originally installed.

Our obligation under this warranty shall be limited to repairing or replacing, including labor, any part of such product, which proves thus defective. Beverage-Air reserves the right to examine any product claimed to be defective.

The labor warranty shall be for self-contained units only and for standard straight time, which is defined as normal service rate time, for service performed during normal working hours. Any service requested outside of a servicer's normal working hours will be covered under this warranty at the normal rate and any additional overtime rate will be at the responsibility of the equipment purchaser.

Any part or accessory determined to be defective in the product should be returned to the company within thirty (30) days under the terms of this warranty and must be accompanied by a record of the cabinet model, serial number, and identified with a return material authorization number (RMA#) issued by the manufacturer.

Special installation/applications, including remote locations, are limited in coverage by this warranty. Any installation that requires extra work, and/or travel, to gain access to the unit for service is the sole responsibility of the equipment purchaser.

Improper operation resulting from factors, including but not limited to, improper or negligent cleaning and maintenance, low voltage conditions, inadequate wiring, outdoor use (unless otherwise specified) and accidental damage are no manufacturing defects and are strictly the responsibility of the purchaser.

With the exception of Blast Chillers product is designed for maintaining temperature and not bringing food to a desired temperature therefore cannot be held responsible for this function under warranty.

Units must be in a conditioned environment or warranty will be void.

Condensing coils must be cleaned at regular intervals. Failure to do so can cause compressor malfunction and will void warranty. Although cleaning requirements vary in accordance with operation of various products, Beverage-Air recommends a minimum monthly cleaning.

### NO CLAIMS CAN BE MADE AGAINST THIS WARRANTY FOR SPOILAGE OF FOOD, PRODUCTS, LOSS OF SALES OR CONSEQUENTIAL DAMAGES.

THE FOREGOING WARRANTIES ARE EXPRESSLY GIVEN IN LIEU OF ALL OTHER WARRANTIES, EXPRESS, IMPLIED, OR STATUTORY, INCLUDING THE IMPLIED WARRANTIES OF MERCHANTABILITY AND FITNESS FOR A PARTICULAR PURPOSE, WHICH ARE HERBY DISCLAIMED, ALL OTHER OBLIGATIONS OR LIABILITIES ON OUR PART, AND WE NEITHER ASSUME, NOR AUTHORIZE ANY OTHER PERSON TO ASSUME FOR US, ANY OBLIGATION OR LIABILITY IN CONNECTION WITH THE SALE OF SAID REFRIGERATION UNITS OR ANY PARTS THERE OF.

This warranty shall not be assignable and shall be honored only in so far as the original purchaser. This warranty does not apply outside the limits of the United States of America and Canada, nor does it apply to any part that has been subject to misuse, neglect alteration, accident, or to any damage caused by transportation, flood, fire, acts of terrorism, or acts of God.

### LIMITATION OF LIABILITY:

Beverage-Air Corporation or their affiliates shall not be liable for any indirect, incidental, special or consequential damages, or losses of a commercial nature arising out of malfunction equipment or its parts components thereof, as a result of defects in material or workmanship.

THE ORIGINAL OWNER'S SOLE AND EXCLUSIVE REMEDY AND BEVERAGE-AIR'S SOLE AND EXCLUSIVE LIABILITY SHALL BE LIMITED TO THE REPAIR OR REPLACEMENT OF PARTS OR COMPONENTS CONTAINED IN THE EQUIPMENT IDENTIFIED ABOVE WHICH UNDER NORMAL USE AND SERVICE MALFUNCTION AS A RESULT OF DEFECTS IN MATERIAL OR WORKMANSHIP, SUBJECT TO THE APPLICABLE PROVISIONS AND LIMITATIONS STATED ABOVE.

Note: Additional Terms and Conditions of sale may apply. Notice: Specifications Subject to Change without Notice. Contact Beverage-Air for specific model agency approval. All prices are ex-works Brookville, Pennsylvania 03/01/2020



# CONTACTS

## 1 CR Peterson

ph: (800) 257-4040  
fax: (508) 238-3647  
email: jim@crpeterson.com  
territory: Maine, New Hampshire, Vermont, Connecticut, Rhode Island, Massachusetts

## 2 J Wilson Marketing

ph: (518) 692-8083  
fax: (518) 692-8084  
email: joe@jwilsonmarketing.com  
territory: New York (except Metro/ NYC)

## 3 TD Marketing

ph: (732) 339-3266  
fax: (732) 902-2636  
email: customerservice@tdmarketingco.com  
territory: New Jersey (Northern half of NJ), New York (Metro)

## 4 BSE Keystone

ph: (800) 242-9095  
fax: (877) 753-5683  
email: dpino@bsereps.com  
territory: Delaware (entire state), Pennsylvania (east of and including Bradford, Lycoming, Milton, Union, Mifflin, Juniata, Perry, Cumberland, & Adam Counties) New Jersey (south of and including Mercer, Burlington, and Ocean counties)

## 5 The Schmid-Wilson Group

ph: (410) 998-9191  
email: swg@theswg.com  
territory: Maryland, District of Columbia, Virginia

## 6 Phoenix Marketing

ph: (317) 986-4167  
email: sammi@phoenix-reps.com  
territory: Indiana, Michigan

## 7 Professional Reps

ph: (877) 995-8922  
fax: (602) 864-1754  
email: sales@goprereps.com  
territory: Ohio, Kentucky, Western quarter of Pennsylvania, West Virginia

## 11 Swanson-Girard

ph: (704) 521-8811  
fax: (704) 521-8801  
email: sgirard@swanson-girard.com  
territory: North Carolina, South Carolina

## 12 Charles Pace & Associates, Inc.

ph: (770) 969-0488  
fax: (770) 969-7277  
email: pace@pacereps.com  
territory: Georgia, Alabama, Tennessee (Central and Eastern), Florida (panhandle)

## 13 Tepper & Associates, Inc.

ph: (727) 322-1212  
fax: (727) 322-1313  
email: info@tepperreps.com  
territory: Florida (except the panhandle)

## 14 Marketing Agents South

ph: (601) 956-4661  
fax: (601) 956-4726  
email: sales@masouth.com  
territory: Mississippi, Western Tennessee, Arkansas, Louisiana

## 15 Ettinger-Rosini/Waypoint

ph: (214) 796-3421  
email: chuck@ettros.com  
territory: Oklahoma, Texas (except El Paso County)

## 16 Central Marketing Associates, Inc.

ph: (913) 897-2390  
fax: (913) 897-2391  
email: steve@cmafoodservice.com  
territory: Missouri, Kansas, Iowa, Nebraska, Illinois (Southern two thirds of state)

## 17 Cassidy's Pro Line

ph: (630) 627-7353  
fax: (630) 628-3529  
email: dennis@cassidysproline.com  
territory: Illinois (Central & Northern)

## 19 The YES Group

ph: (651) 452-9889  
fax: (651) 452-3804  
email: sales@theyesgroup.com  
territory: Minnesota, North Dakota, South Dakota, Wisconsin

## 20 Professional Reps

ph: (877) 995-8922  
fax: (602) 864-1754  
email: sales@goprereps.com  
territory: Arizona, Colorado, New Mexico, Utah, Wyoming, Texas (El Paso County only)

## 22 Lund-Iorio

ph: (949) 443-4855  
fax: (949) 443-4856  
email: scott@lund-iorio.com  
territory: Nevada (Clark County), California (CA/Mexico border and southern third of state)

## 24 Walter Zebrowski Associates

ph: (415) 883-3222  
fax: (415) 883-9332  
email: tom@walterzebrowskiassoc.com  
territory: Nevada (entire state except Clark County), California (Northern two thirds of state)

## 25 Kelly-Mincks

ph: (425) 481-9036  
fax: (425) 806-5283  
email: james@kelly-mincks.com  
territory: Washington, Oregon, Alaska, Montana, Idaho, Hawaii

## 26 W.D. Colledge

Services 26a - 26f  
ph: (604) 999-8579  
fax: (905) 677-5337  
email: tmoffatt@wdcolledge.com  
territory: Canada

**Factory Headquarters Sales Office**

3779 Champion Blvd  
Winston-Salem, NC 27105  
Phone: (336) 245-6400  
Fax: (336) 245-6453  
Email: sales@bevair.com  
Web: www.beverage-air.com

**Food Service Manufacturing Facility**

Parts RG's:  
1082 Route 28  
Brookville, PA 15825

Equipment RG's:  
1082 Route 28  
Brookville, PA 15825

**Warranty Service**

(877) 866-1223

**Factory Technical Service**

Phone: (800) 684-1199  
Fax: (800) 262-9381

**Factory Customer Service**

Phone: (888) 845-9800  
Fax: (800) 253-5168

**For warranty services  
please call Warranty Dispatch  
at (877) 866-1223 or you can  
email dispatch@alirefna.com  
M-F 8am-5pm EST.**

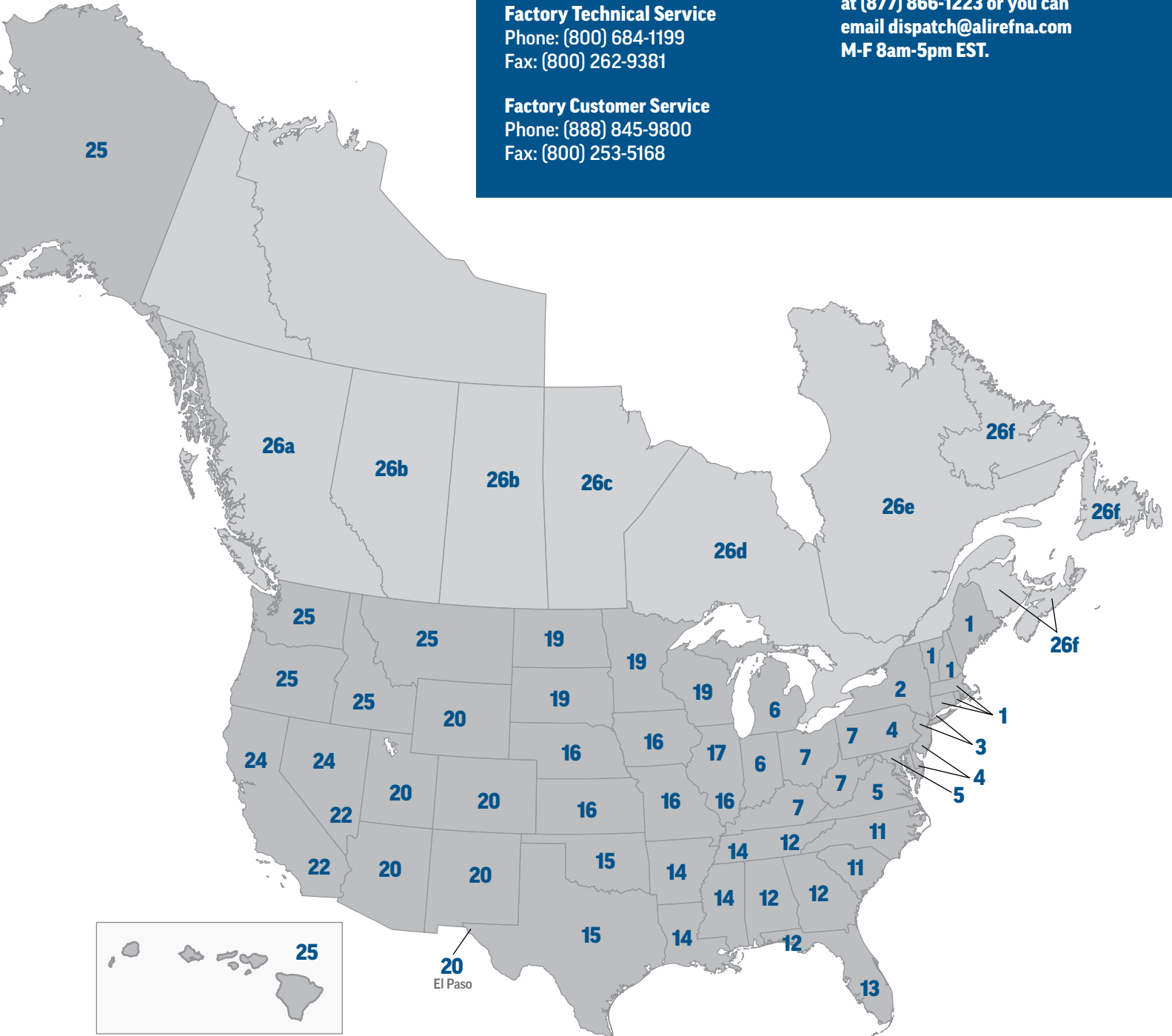

CHECK OUT THE ALL NEW

# beverage-air.com



More content, more info, improved navigation.  
**Visit the new website today!**

MASTER20230201

an Ali Group Company



The Spirit of Excellence

2023 BEVAG-RAVG-GEVA-RVAG-LOG-ALOG-888-815-9800 [bevg-air.com](http://bevg-air.com)